

ADVANTAGE™

ISSUE 2 | 2018

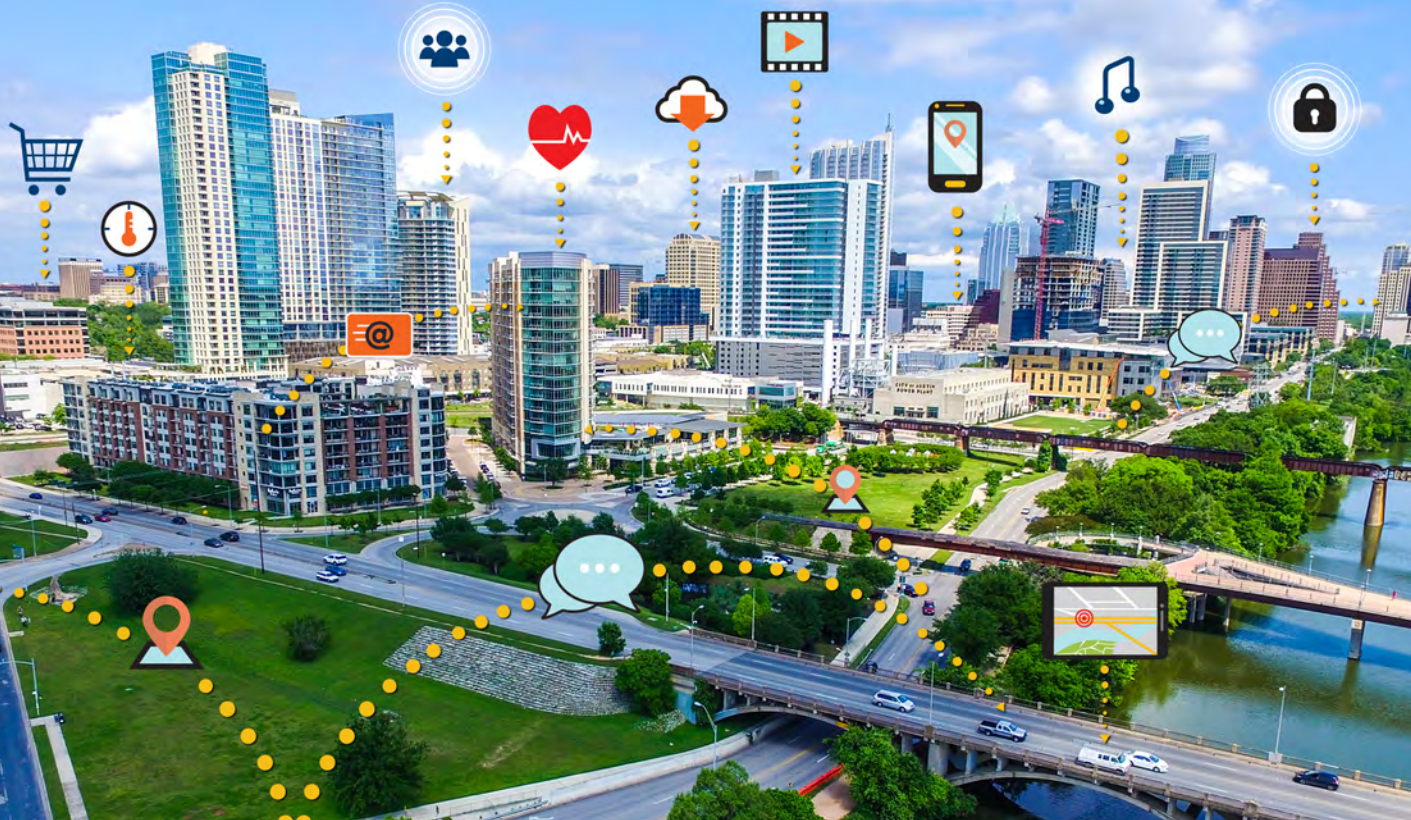

SMART CONNECTED PRODUCTS

14 5G Antenna Technology
for smart products

18 Cool Smartphones
Temperature management

**30 Brain Trust for
Aneurysm Treatment**
Digital twin for healthcare

Flexible **Solutions** for the Engineering World

- Optimized compute platforms for CAE workloads
- Remote graphics and batch scheduling enabled
- Maximize efficiency of available licenses
- Simplified integration within existing infrastructures
- Built with the latest Intel® Xeon® Processors

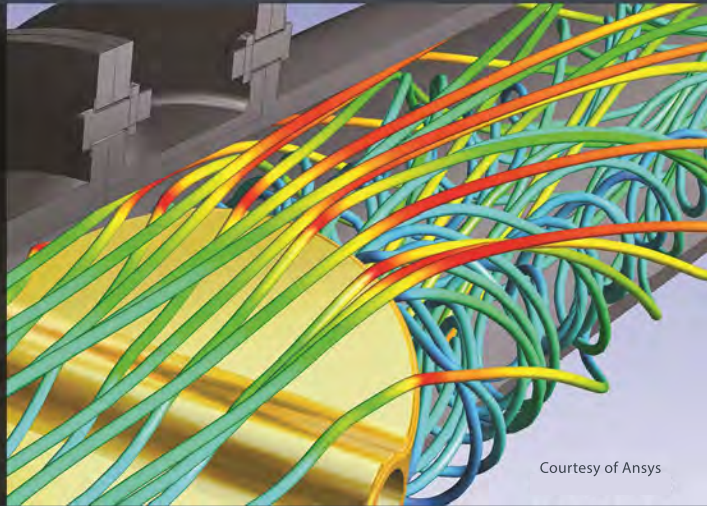

Courtesy of Ansys

www.hpe.com/info/hpc-manufacturing-and-engineering

© Copyright 2017 Hewlett Packard Enterprise Development LP
© Copyright 2017 Intel, the Intel logo is trademark or registered trademark of Intel Corporation in the U.S. and/or other countries

Hewlett Packard
Enterprise



Get Caught Up

Past issues of *Ansys Advantage*
are always available at

ansys.com/archive



ADVANTAGE™

Smart Connected Products: *Taking the First Step*



By **Robert Harwood**
Global Industry Director
Ansys

The pace at which these broad changes occur is only accelerating. In 2016, Ansys quoted research that suggests there would be 26 billion personal devices by 2020, generating approximately \$1.9 trillion in global economic value. Today's research suggests that 127 new connected devices go live every second — and the predictions of global economic impact are as high as \$11 trillion. With the advent of 5G, that acceleration will only increase.

Here at Ansys, we are also accelerating the pace at which our simulation technology evolves, to continue anticipating the new demands of our customers. Two years ago the term digital twin, a concept enabled by smart connected products, was barely in the global lexicon. Today it is becoming ubiquitous. We recently launched the Ansys Twin Builder solution, which represents one more way our customers can leverage smart connected technology to realize value

Two years ago, we published an issue of *Ansys Advantage* that focused on the Internet of Things (IoT) and how increased connectivity of products — ranging from personal electronics to highly complex industrial machines — was making the job of the product development engineer even more difficult. Back then, there was significant hype around the IoT, but, with the exception of a few early adopters, little clarity about what connected products would actually mean for businesses both large and small.

Through conversations with industry experts, as well as my personal observations, I have discovered that a lot has changed since then. The dialogue has shifted from “What exactly is the IoT?” to “Given the importance of connected products, how can our business maximize this financial opportunity?”

Not only have numerous companies, of all sizes, launched digitalization initiatives that leverage new product technology, they have also implemented entirely new business models that capitalize on the data being collected by an ever-expanding number of connected devices. Once seen as a byproduct of connectivity, today that data is appreciated for its tremendous strategic and financial value.

by developing physics-based digital twins of their physical operational assets.

Yet, for many of our customers, the question remains: “How can we begin to capitalize on smart connected product technology?” Because every company is unique, this process must

environments. It must perform reliably and in a functionally safe manner in harsh environments, yet maintain a practical form and weight. The embedded code that controls its behavior and displays its outputs must conform to industry standards and best practices. Today, more than

“How can we begin to capitalize on smart connected product technology?”

begin by identifying the business case and mapping a clear path to value. The next step on the journey is adding “smart” and “connected” functionality to an existing product, or building these capabilities into new products, in a way that customers see as valuable.

This takes ingenuity. That's why it falls to the engineer to rise to the associated challenges — which are numerous. A smart connected product needs power, and it needs to endure. It needs to connect consistently and often in conflicting electromagnetic

environments. It must perform reliably and in a functionally safe manner in harsh environments, yet maintain a practical form and weight. The embedded code that controls its behavior and displays its outputs must conform to industry standards and best practices. Today, more than ever, integrated multidisciplinary simulation is required to explore these myriad, interdependent design variables and trade-offs and arrive at optimal decisions.

As the IoT continues to mature, this edition of *Ansys Advantage* highlights engineering teams who are making a meaningful difference in their companies by supporting the journey to value-added smart connected products. By developing highly innovative solutions and helping to create entirely new business models, they are defining the future — and determining what we will be talking about in the next few years. ▲

Table of Contents

Spotlight on Smart Connected Products

4

BEST PRACTICES

Making Smart Products Smarter, More Connected and More Efficient

How can engineering teams quickly master the complexities of power efficiency, signal integrity and other design challenges as they deliver ongoing innovations for smart connected products? The answer is simulation.

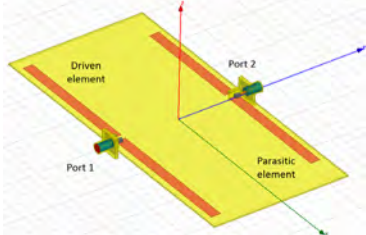

10

ELECTRONICS

Pointing RFIDs in the Right Direction

Using simulation, engineers virtually evaluated new concepts for RFID systems to significantly reduce product development lead time.

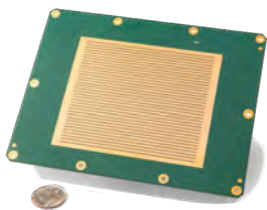

14

HIGH-TECH

5G Antenna Technology for Smart Products

5G must address more communications over limited bandwidth using new antenna technology.



18

HIGH-TECH

Cool Smartphones

Qualcomm engineers simulate the power sources in a smartphone in a fraction of the time required by a full thermal analysis.

22

AEROSPACE AND DEFENSE

Balloon-Borne Vehicles Provide a Bird's-Eye View

World View engineers saved an estimated eight months and about \$600,000 by employing simulation to determine the right design before building and testing a prototype of a balloon-borne vehicle to replace satellites.

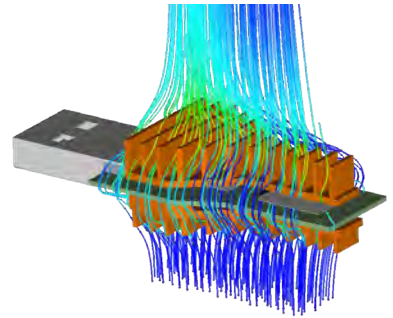

26

HIGH-TECH

Cutting the Cords

Engineers leveraged Ansys simulation to address thermal issues caused by packing high-power transmitters into a tiny enclosure.

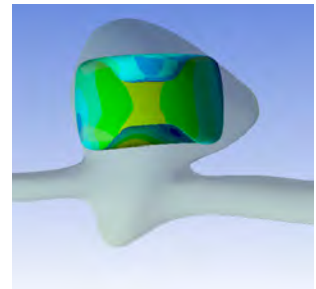

30

HEALTHCARE

Brain Trust for Aneurysm Treatment

To provide effective treatment for brain aneurysms, a company has developed a digital twin to help physicians place implant devices during surgery.

ABOUT THE COVER

Smart connected products are everywhere. Simulation is the only practical way to make the trade-offs required to ensure that these systems and devices are reliable and cost-effective in a rapidly changing marketplace.



34

AUTOMOTIVE

Breaking Story on an Automotive Power Module

Engineers employed Ansys structural capabilities to develop a reliable power steering module in half the time required in the past.



38

THOUGHT LEADER

Aiming High

By developing microsattellites, startup Vector is opening up the space race to a new generation of small and midsized businesses.

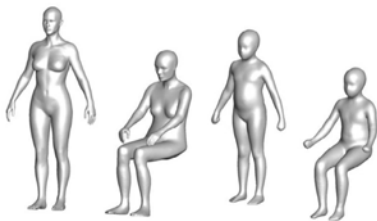

42

HEALTHCARE

Targeting a Tumor

By creating a human digital twin, researchers can target a drug on a lung tumor with 90 percent efficiency.

SIMULATION@WORK

46

AUTOMOTIVE

Cool Idea for Engine Design

A radically improved two-stroke opposed-piston internal combustion engine increases fuel efficiency and reduces greenhouse gas emissions.

DEPARTMENTS

50

SOLUTIONS

A Closer Look at Optical Simulation

With its acquisition of OPTIS, Ansys has expanded its software portfolio to include the engineering simulation of light, human vision and physics-based visualization.



54

NEWS

Simulation in the News

A roundup of news items featuring simulation

WEB EXCLUSIVE

THOUGHT LEADER

Connected and Autonomous Vehicles — A Thought Leader's Perspective

Professor Burkhard Goeschel shares his insights into the new world of autonomous vehicles and connectivity.

Join the simulation conversation



Welcome to *Ansys Advantage!* We hope you enjoy this issue containing articles by Ansys customers, staff and partners.

The Editorial Staff, *Ansys Advantage*
ansys-advantage@ansys.com

Executive & Managing Editor
Chris Reeves

Editorial Advisers
Amy Pietzak, Tom Smithyman

Editorial Contributor
Ansys Customer Excellence
North America

Senior Editor Tim Palucka
Designer Dan Hart Design

Editors
Erik Ferguson Mark Ravenstahl
Kara Gremillion Walter Scott
Thomas Matich Terri Sota

Art Director
Ron Santillo

ANSYS, Inc.
Southpointe
2600 Ansys Drive
Canonsburg, PA
15317
USA

Subscribe at ansys.com/magazine

Realize Your Product Promise®

If you've ever seen a rocket launch, flown on an airplane, driven a car, used a computer, touched a mobile device, crossed a bridge, or put on wearable technology, chances are you've used a product where Ansys software played a critical role in its creation.

Ansys is the global leader in engineering simulation. We help the world's most innovative companies deliver radically better products to their customers. By offering the best and broadest portfolio of engineering simulation software, we help them solve the most complex design challenges and engineer products limited only by imagination.

Neither Ansys, Inc. nor Dan Hart Design guarantees or warrants accuracy or completeness of the material contained in this publication.

ACT, Additive Suite, AIM, Aqwa, Autodyn, BladeModeler, CFD, CFD Enterprise, CFD Flo, CFD Premium, CFX, Chemkin-Pro, Cloud Gateway, Customization Suite, DesignerRE, DesignerSI, DesignModeler, DesignSpace, DesignXplorer, Discovery Live, EKM, Electronics Desktop, Elastic Licensing, Enterprise Cloud, Engineering Knowledge Manager, EnSight, Explicit STR, Fatigue, FENSAP-ICE, FENSAP-ICE-TURBO, Fluent, Forte, Full-Wave SPICE, HFSS, High Performance Computing, HPC, HPC Parametric Pack, Icepak, Maxwell, Mechanical, Mechanical Enterprise, Mechanical Premium, Mechanical Pro, Meshing, Multiphysics, Nexxim, OptiMetrics, OptiLang, ParICs, PathFinder, Path FX, Pervasive Engineering Simulation, PExprt, Polyflow, PowerArtist, Professional, Professional NLS, Professional NLT, Q3D Extractor, RedHawk, RedHawk-SC, RedHawk-CTA, Rigid Body Dynamics, RMXprt, SCADE Architect, SCADE Display, SCADE LifeCycle, SCADE Suite, SCADE Test, SeaHawk, SeaScape, Siwave, Simplorer, Solver on Demand, SpaceClaim, SpaceClaim Direct Modeler, Structural, TGrid, Totem, TPA, TurboGrid, Twin Builder, Workbench, Vista TF, Realize Your Product Promise, Sentinel, Simulation-Driven Product Development

ICEM CFD is a trademark licensed by Ansys, Inc. LS-DYNA is a registered trademark of Livermore Software Technology Corporation. nCode DesignLife is a trademark of HBM nCode. All other brand, product, service, and feature names or trademarks are the property of their respective owners.

MAKING SMART PRODUCTS

Smarter, More Connected and More Efficient



Smart functionality and connectivity are no longer options for product development teams – they have quickly become a competitive imperative. How can engineering teams quickly master the complexities of power efficiency, signal integrity and other design challenges as they deliver ongoing innovations? The answer, in a word, is simulation.

By **Sudhir Sharma**, Global Industry Director for High-Tech, Ansys



Two years ago, most companies were just beginning to grapple with issues like connectivity and thermal management as they related to forward-looking smart product designs. Now, no one is asking, “Do we need smart functionality?” Instead, product development teams and executives alike are asking, “How do we design the most innovative smart products to win in the digital economy?”

Ansys has been helping companies develop complex products for a long time — but, in the smart connected product era, the engineering challenges have become more intense. Miniaturized, multifunctional devices now proliferate across the globe, which may mean that they need to operate in harsher environments, consume power more efficiently and offer more digital functionality to keep pace with the market’s growing expectations. They need to become intelligent by sensing their environment and gathering data more accurately than ever to inform future product development and stay one step ahead of global competitors.

Wherever they are in their own engineering journey, product development teams can leverage the Ansys comprehensive simulation portfolio to solve design challenges in five critical areas:

- Size, weight, power and cooling (SWaP-C)
- Sensing and connectivity
- Reliability and safety
- Systems integration
- Product durability

These five areas represent incredibly complex engineering challenges — yet overcoming them is essential to realizing the full potential of the next generation of smart connected products.

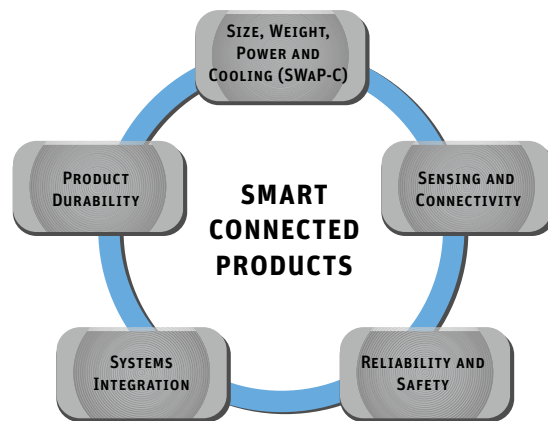

Size, Weight, Power and Cooling

As product development teams race to offer increased digital functionality, while simultaneously making their designs smaller and lighter, they must address the problem of thermal buildup, design for harsher environmental conditions and deliver all these innovations quickly and cost-effectively.

Simulation remains the only practical way to make informed design trade-offs to achieve size, weight, power and cooling objectives for today’s complex products. Via a range of physics simulation capabilities in the Ansys technology platform, product developers can quickly explore, analyze and iterate design ideas to obtain the optimal balance between power, performance, thermal reliability and structural integrity. Without simulation, many of today’s most ambitious smart connected products would not have been delivered to the market.

As one example, Peraso Technologies engineers developed a tiny chipset for a USB stick that uses a SuperSpeed USB 3.0 port to achieve high wireless processing speeds. Peraso leveraged Ansys multiphysics software to address the thermal issues inherent in loading high-power transmitters into a very small package — reducing the thermal design cycle time by two-thirds. (Read the full story on page 26.)

For companies with less dramatic design goals — for example, manufacturers of traditional products who are incorporating sensors or other digital components for the first time — simulation proves equally valuable. These product development teams can easily make trade-offs and produce a balanced design before committing to the high costs associated with physical prototyping and production.



Why Engineering Simulation is Critical to Your Smart Product’s Success
ansys.com/smart

“Simulation remains the only practical way to make informed design trade-offs to achieve size, weight, power and cooling objectives.”

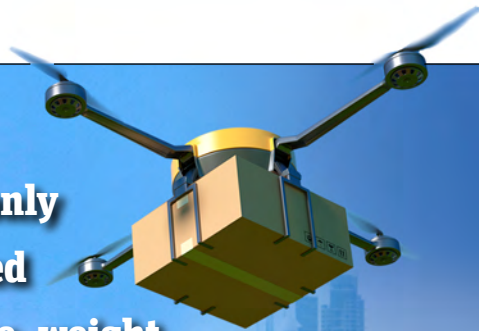

Sensing and Connectivity

Sensing is one of the most fundamental capabilities of any smart connected product. An enormous amount of data must be collected — in real time and under unpredictable conditions — to support safe and reliable operation. Sensing is central to performance in just about every application for a smart connected design, including autonomous vehicles. Accurately collecting data via sensors, and communicating that information reliably are essential capabilities that enable data processing systems to analyze the information and make the right decisions.

With the advent of fifth-generation (5G) wireless communications, peak data rates are expected to be 20 times faster than those enabled by existing 4G technologies. Forward-looking 5G architects are

aiming to address a range of applications, including machine-to-machine communications, smart city and smart home designs, autonomous vehicles, and multimedia streaming technologies. Achieving the right trade-offs to deliver on these capabilities will require improvements in sensor reliability as well new radio-frequency (RF) architectures — including massive multiple-input and multiple-output (MIMO) systems and beamforming antenna designs.

Engineers are already using Ansys simulation tools to accurately recreate a real-world environment in a risk-free virtual design space. Designers can evaluate thousands of product scenarios and answer what-if questions as they vary the physical environment in which sensor designs are operating. For example, using shooting and bouncing ray (SBR) simulation technology

from Ansys, engineering teams can accurately predict and improve the real-world performance of antennas. This capability can be very helpful for engineers developing wireless sensor networks, as well as designers of automotive radars.

MaiSense — a company that designs sensors for autonomous vehicles — is focused on developing new 4D sensor technology that detects the velocity of objects around it. This is critical in enabling vehicles to distinguish a stationary object like a fire hydrant from a living, breathing toddler who may enter the street. Engineers at MaiSense have used Ansys HFSS and HFSS SBR+ to develop and verify a novel sensor technology that detects motion and velocity, along with algorithms that process this information intelligently.

Reliability and Safety

Though invisible, millions of lines of embedded software code form the foundation for every smart connected product. A single flaw in this code can have dramatic implications, especially in safety-critical applications such as transportation and healthcare.

Modern cars are among the most complex machines ever developed, with control software consisting of more than 100 million lines of code. Infotainment systems, assistive parking technologies, adaptive cruise control, collision detection systems, navigation aids, heads-up displays and other technologies provide value, convenience and safety to today's drivers. However, testing





these systems is a nightmare for engineers. One small flaw, buried somewhere in the millions of lines of code or complex circuit designs, could lead to a catastrophic outcome. Should one component fail, the underlying code needs to support the functional safety of all the other systems and components.

For autonomous vehicles, the engineering challenge is only amplified. It is estimated that a Level 5 autonomous vehicle — which requires no human intervention — would need 8 billion miles of testing in order to be certified. At the present rate of road testing, more than 400 years would be needed to accomplish this task.

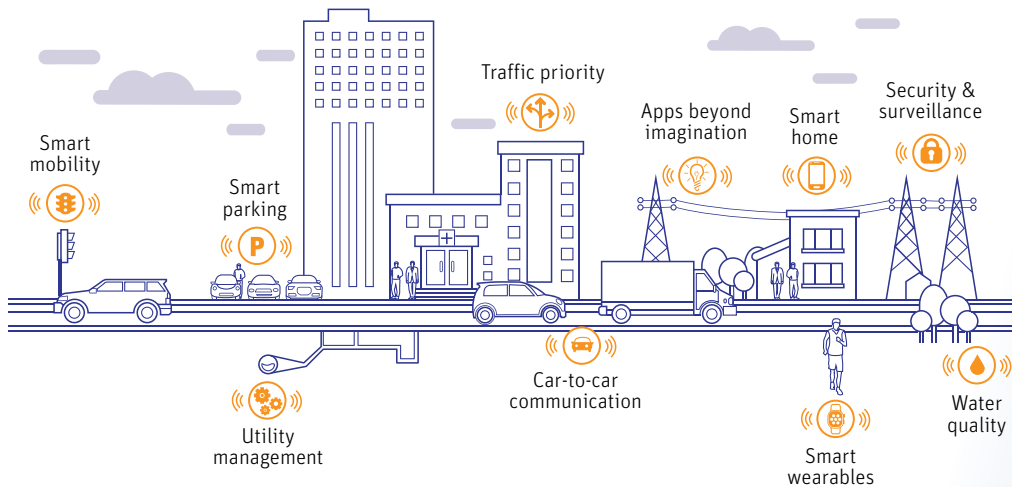

The reliable performance of connected medical devices and medication dispensers is also dependent on software that needs to comply with critical design standards, such as IEC 62304. In the aerospace industry, it has been estimated that jets such as the Boeing 787 rely on more than 8 million lines of embedded code. It is easy to see the critical importance of this code for protecting human health and safety.

Traditional manual methods for verifying the operation of software are no longer sufficient. The process is time-consuming, prone to error and not practically viable because of the size and scope of the software. Simulation-supported software design not only drives significant time and expenses out of the development cycle — supporting fast, profitable market launches — but also increases the functional safety of the final product system.

Piaggio Aerospace, a global provider of aviation technology, has been able to reduce its overall development cycle by a factor of three by leveraging the power of Ansys SCADE solutions.



“The challenges associated with delivering *smart connected designs* have placed enormous pressures on the world’s engineering teams.”



The company is able to produce mission-critical software quickly, remove functional bugs and reduce the number of expensive test demonstrations by using SCADE to automate and accelerate this once time-consuming manual process. [1]

Systems Integration

Smart connected products are made up of many components that are supported by invisible networks that connect them, as well as clouds that store and deliver data to them. These components are typically produced by different design teams — often in partnership with a network of suppliers — and are only brought together at a relatively late design stage to create the cohesive smart connected product system. As just one example, engineers at Starkey Hearing Technologies are tasked with designing smart hearing aids that combine more than 60 tiny components that must work flawlessly with one another, along with the wearer’s unique body type. [2]



When diverse components are assembled, unanticipated performance issues such as the interactions of the software and the electronics hardware often occur. The multidomain nature of these problems, and the sheer number of component suppliers, makes them hard to study in advance. However, simulation software from Ansys provides early-stage validation results by allowing engineers to assemble the product system in a virtual design space — revealing

systems-level qualities, properties, characteristics, functions, behaviors and performance. Based on this high-level perspective, system designers can make informed design choices that optimize the performance of not only each individual component, but also the entire system.

By applying Ansys multiphysics solutions to couple the physical attributes of a product with the systems and embedded software, companies can greatly minimize integration issues, reduce costs, increase the likelihood of first-pass success and ensure that products perform as expected.

Recently, product developers at Integrated Micro-Electronics were faced with system-level troubleshooting in designing an electronic automotive power module with multiple components. When the module buckled during physical testing, the engineering team needed to identify why this failure occurred. Using multiphysics Ansys solutions, the Integrated Micro-Electronics team was able to replace eight months of physical testing with four months of system-level simulation that revealed the integration issue. (Want to learn more? See page 34.)

Product Durability

Smart connected products operate in a wide range of physical environments, with ever-changing and unpredictable conditions. Consider the extreme conditions routinely faced by jets, drones, oil and gas equipment, and other product systems used in transportation and industrial applications. To cite a statistic that hits closer to home, SquareTrade estimates that dropped smartphones have



cost American consumers more than \$10.7 billion. [3] To maximize product life, increase customer satisfaction and minimize warranty costs, all smart connected products, from smartphones to satellites, must be designed with real-world operating conditions in mind.

It would be impossible to predict every physical force and temperature extreme, then subject a physical prototype to those conditions. However, simulation allows product developers to test their designs under thousands of operating parameters and accurately predict performance early in the development process, when design choices can be made at the lowest cost — and with the least impact on the project schedule.

Vector is poised to revolutionize the satellite industry by sending a new generation of micro-satellites into space via its rockets and launch systems. These rockets must endure incredibly harsh conditions — including speeds in excess of Mach 6, along with temperatures from -160 C to $3,000\text{ C}$. Because it is impossible to cost-effectively replicate these conditions in iterative physical tests, this ambitious startup relies on Ansys engineering simulation to study the full range of fluid and mechanical forces that will impact its rockets. (Turn to page 38 to read the full article.)

Smart Products Require Intelligent Engineering

The advent of smart connected products has changed our daily lives, and the way companies work, in large and small ways. And these products are poised to deliver even greater benefits. However, the challenges associated with delivering smart connected designs have placed enormous pressures on the world's engineering teams. Customers are demanding more and more functionality, at lower price points and in smaller product sizes. And, in mission-critical applications like transportation and healthcare, the safety stakes have never been higher as products become increasingly autonomous.

Whether you already engineer smart connected products or are challenged to incorporate new functionality into a traditional product design, this issue of *Ansys Advantage* demonstrates the real value of simulation in making intelligent trade-offs and arriving at optimal decisions. With the industry's broadest simulation portfolio, Ansys can help you make your products smarter, more connected and more efficient. ⚠



References

- [1] Ansys Customer Case Study: Piaggio Aero. [youtube.com/watch?v=u_fAwW-d50Q](https://www.youtube.com/watch?v=u_fAwW-d50Q)
- [2] Murray, C. I Hear You, *Ansys Advantage*, 2015, Volume IX, Issue 1.
- [3] SquareTrade, New Study Shows Damaged iPhones Cost Americans \$10.7 Billion, \$4.8B in the Last Two Years Alone. [squaretrade.com/press/new-study-shows-damaged-iphones-cost-americans-10.7billion-4.8b-in-the-last-two-years-alone](https://www.squaretrade.com/press/new-study-shows-damaged-iphones-cost-americans-10.7billion-4.8b-in-the-last-two-years-alone) (05/02/2018).

Pointing RFIDs in the Right Direction

Radio frequency identification (RFID) tags provide a superior level of inventory management, asset tracking and supply chain management over barcode technology, which requires barcodes to be within sight of the reader. RFID technology can be more broadly applied and becomes increasingly accurate by boosting the range at which tags can be read. Engineers at Honeywell leveraged Ansys HFSS electromagnetic field simulation software to improve upon current RFID systems. Using HFSS, they were able to virtually evaluate new concepts in less time, significantly reducing product development lead time.

By **Pavel Nikitin**, formerly Principal RF Engineer, Honeywell, Lynnwood, USA

Photograph courtesy of Honeywell International Inc.

Radio-frequency identification (RFID) uses electromagnetic fields to automatically identify and track tags attached to objects. RFID tags are used in supply chain management in many industries to, for example, automate tracking of pharmaceuticals from the production plant to the pharmacy shelves. Accurate tracking reduces inventory levels and prevents counterfeiting. It is a growing and evolving market. RFID technology today extends beyond pure identification and now encompasses intelligent devices and systems with sensing, networking, security, and localization capabilities, and applications ranging from healthcare technology to vehicle identification.

Unlike barcode technology, an RFID tag does not require the tag to be in the line of sight of the reader. Barcodes must be aligned with an optical reader to properly capture the information, whereas RFID tags backscatter data to the reader using RF waves. Improving RFID systems is one of many areas of research at Honeywell, which invents and manufactures technologies that address some of the world’s most critical challenges around energy, safety, security, productivity and global urbanization. The company is one of the top 100 global innovators as determined by Clarivate Analytics, based on an analysis of patent volume, patent-grant success rates, global reach and invention influence.

RFID tags are almost always passive (powered only by RF) to reduce their cost and increase their lifespan. Passive RFID tags harvest power from the electromagnetic waves produced by the RFID tag reader. The lack of an internal power source limits the range at which tags can be read. This can be a concern in some applications, such as in larger warehouses. One approach to increasing the range at which passive RFID tags can be read is to employ a reconfigurable antenna that concentrates all the wireless power generated by the reader in a single direction that changes as the reader scans its environment for tags. This approach was, before now, complex and costly because today’s reconfigurable antennas require a network of control and power lines, and associated circuitry, which substantially increases the cost and complexity of the antenna. Honeywell proposed powering these switches by harvesting wireless energy from the antenna itself and controlling the switches through the wireless signal, substantially reducing the cost of making the antenna directional.

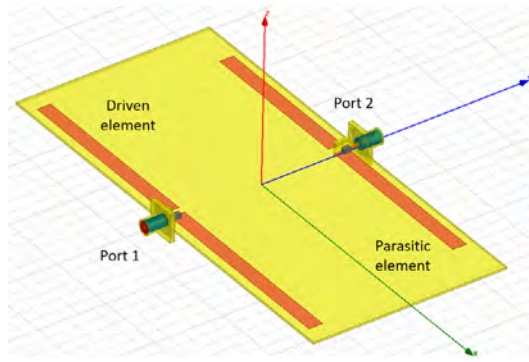

Ansys HFSS model of antenna design

Engineers developed a proof of concept for this approach using Ansys HFSS electromagnetic field simulation software, which allowed them to iterate through the design concepts in only a few minutes each. Honeywell believes this technology has potential and has filed several patents on it. A paper on this topic was selected as the best paper at the 11th Annual International IEEE 2017 Conference on RFID.

The Basic Approach

Honeywell’s proof-of-concept design consists of a two-element planar Yagi array with a main driven element and a parasitic element. A self-oscillating RF-powered switching circuit periodically switches

between two complex impedance values to turn the parasitic element into either a director or a reflector, based on the effect of the reactive load on the antenna parasitic element. This concentrates the power of the antenna in either one direction or the other. Engineers wanted to harvest enough power from a 20 dBm RF source to change the direction of the antenna

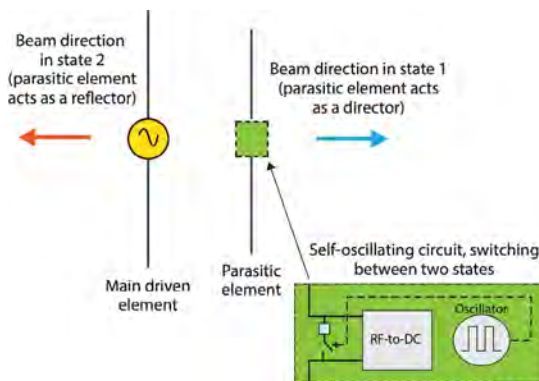

Schematic of new reconfigurable antenna design



“Engineers developed a proof of concept for this approach using Ansys HFSS electromagnetic field simulation software to evaluate new concepts in only a few minutes.”

Photograph courtesy of Honeywell International Inc.

by 180 degrees each time the circuit switches between the two states. They designed a discrete multistage RF-to-DC power harvesting circuit, like those used in many RFID tag front ends, feeding a simple oscillator. The circuit oscillates and modulates its RF input port, in the same way that an RFID tag integrated circuit (IC) modulates its antenna port.

The circuit was designed so that when it is driven with a 10 dBm unmodulated RF signal at 900 MHz, it oscillates with a frequency of approximately 0.5 Hz, spending about 1 second in each switched state. This is long enough for the reader to read most of the tags in the beam's current direction before it is redirected.

Honeywell engineers built the switching circuit on a breadboard. They measured the impedance

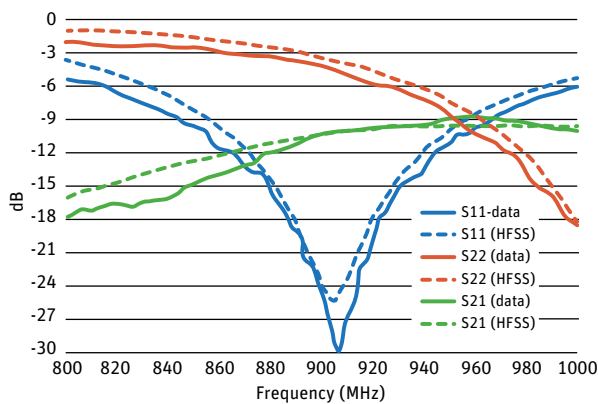

Measured and simulated S-parameters of the final design match up well.

values of the circuit at 900 MHz at several different power levels as inputs for their antenna design. The main design parameters that affect the performance of the antenna are the length of the director, length of the reflector and spacing between the two elements. Without simulation, engineers would have used the build-and-test method,

prototyping the antenna using copper traces on 30-mil FR4 substrate, and then connecting the switching circuit to the antenna and measuring the overall performance under load. This would have taken about an hour per iteration. Not enough time was available to pursue this project using this approach.

Using Simulation to Drive the Design Process

Instead, Honeywell engineers used Ansys HFSS to drive the antenna design. The initial antenna design was modeled in HFSS using one driven element and one parasitic element. Both elements are 5-mm-wide planar copper traces, spaced 60 mm apart on a 30-mil FR4 substrate with a dielectric permittivity of 4.4. Port 1 is the input port of the antenna, and Port 2 connects to the switching circuit. The antenna was designed to operate at 900 MHz. Engineers used the coaxial connector model from the HFSS library for the two coaxial connectors.

These connectors are standardized except for the base that attaches to the circuit board. Engineers measured the width of the connector and length of the pins and modified the model to match the physical connectors.

Engineers first simulated 10 different initial designs to evaluate the effects of spacing between the two antenna elements. They selected a spacing that provides about a 4 dBi directional gain in each state. Next, they used the parametric analysis capability

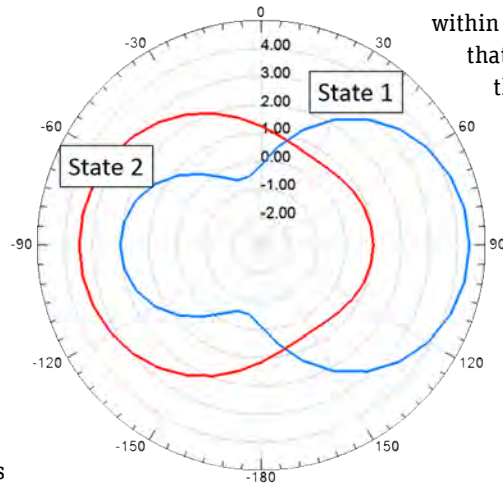

Simulated antenna radiation pattern with radial axis representing realized gain at 900 MHz in YZ plane

within HFSS to run 100 different cases that explored every combination of the 10 different lengths for each antenna element. This process was then repeated for several different impedance values of the loading circuit, available from measurements using different RF input power. Engineers configured HFSS to run through these designs without user intervention and calculated their radiation pattern and S-parameters. They examined the results and selected the best designs for further exploration. The simulation predicted that the best design would deliver a radiation

pattern that concentrated the vast majority of the power of the antenna alternately into two states that had little overlap yet covered 360 degrees.

Simulation Predictions Match Physical Measurements

Next, engineers built a physical prototype of the antenna and compared its performance to the model. The simulated S-parameters were in good agreement with experimental measurements. Engineers also verified the switching beam behavior of the antenna by constructing a simple experimental test setup. An RF signal generator transmitted a 20 dBm 900 MHz signal into the antenna. During the switching cycle, the received RF power for maximum gain beam direction (state 1) changed by approximately 3 dB, matching the simulated radiation patterns. The full radiation pattern was then measured using a more complex setup described in the reference.

Honeywell has filed patents and is considering licensing this technology to outside interests. The device can be built as a research project; all necessary information is in the referenced IEEE paper.

Wirelessly powered reconfigurable antennas have the potential to increase the range of RFID readers at a relatively low cost. This new approach does not require adding power or control lines to operate the switching circuit, so it can easily be retrofitted to existing RFID readers that transmit sufficient power. This concept may pave the way to building other reconfigurable electronic components such as filters and amplifiers. ⚠️

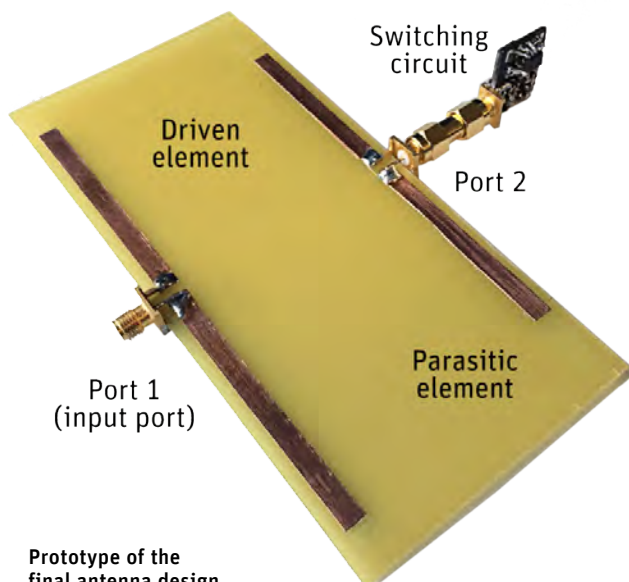

Prototype of the final antenna design

Reference

Nikitin, P. Self-reconfigurable RFID Reader Antenna, *2017 IEEE International Conference on RFID (RFID)*, Phoenix, AZ. 2017. pp. 88–95.

5G Antenna Technology for Smart Products



By **Eric Black**
Chief Technology Officer
Pivotal Commware
Kirkland, USA

The dramatic rise of smart connected products requires a rapidly increasing communications bandwidth, but the radio frequency spectrum available is growing at a much slower pace than what is needed. One way the fifth generation of cellular wireless technology, 5G, can address this problem is by leveraging beamforming antennas to send different signals to different areas of the cellular network, enabling multiple simultaneous transmissions at the same time on the same frequency. Pivotal Commware is designing the next generation of these beamforming antennas for cellular base stations and other applications, at a fraction of the cost of existing methods. The company's engineers use Ansys HFSS to create antenna designs that meet design requirements on the first or second pass, substantially reducing the time required to bring new antennas to market in this highly competitive industry.

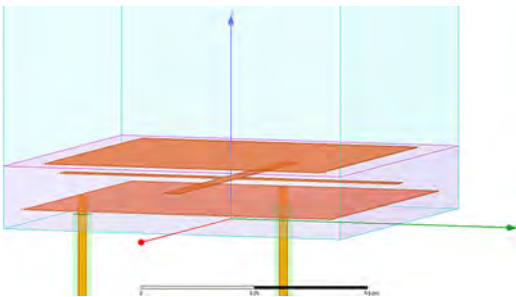

Floquet analysis generates infinite arrays from a single antenna element.

Previous 3G and 4G LTE cellular technology perfected the process of dividing frequency bands into ever-narrower segments and splitting time into smaller and smaller pulses to increase the number of mobile phone users that can be accommodated by the network. Pivotal Commware addresses 5G's new focus on subdividing space with Pivotal's holographic beamforming (HBF) antenna technology. HBF uses varactors, electronic components that are far simpler and less expensive than the complex electronics used in existing beamforming antennas such as phased arrays or multiple-input multiple-output (MIMO).

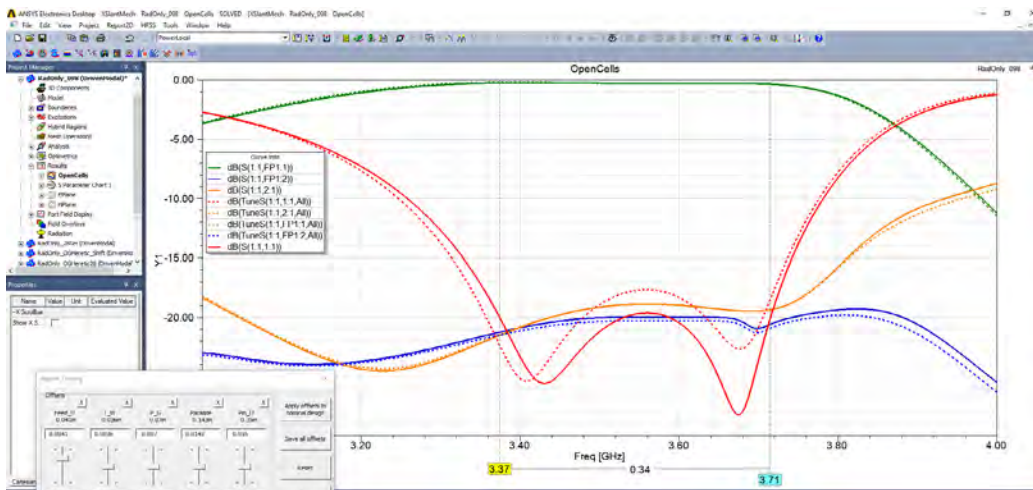

Derivative tuning allows fine adjustments without the need for additional simulation runs.

Cost, size, weight and power (C-SWaP) are critical challenges in communication system design. Using the traditional approach of building a prototype over the course of a month – determining any flaws, creating a new design and so on – it would be impossible to meet product launch schedules. Instead, Pivotal engineers use Ansys HFSS, obtained through the Ansys Startup Program, to design all key components of its 5G antennas – transitions, feed networks, couplers, RF/DC blocks, transmission lines and radiating elements. Ansys simulation tools enable Pivotal's holographic beamforming technology to overcome the C-SWaP challenge. Leveraging simulation, engineers obtain a reliable design early in the development process and avoid multiple prototype iterations required by traditional design methods.

Beamforming Key to 5G Performance

In 4G LTE, cellular technology has reached the theoretical limits of time and frequency multiplexing, so engineers are looking at using software-driven, highly directional antennas to slice up physical space. This will enable mobile phone users in different locations within a cellular network to share the same frequency simultaneously. A leading technology in this space is MIMO, which uses many transmitters and receivers to excite the various elements in each antenna to transmit data streams that can later combine despite traveling different paths. However, MIMO requires a complex and costly baseband unit (BBU) to coordinate the system and radios behind every element, which results in high cost and power consumption.

Holographic beamforming, on the other hand, uses a single varactor (variable capacitors whose capacitance depends on DC bias) per antenna element to direct wireless

“Cost, size, weight and power (C-SWaP) are critical challenges in communication system design.”

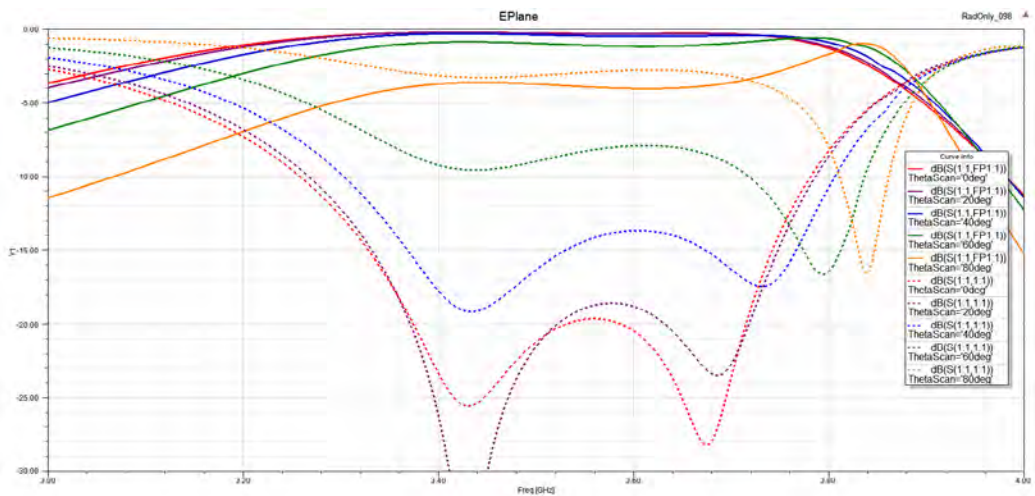

A parametric study identifies roll-off as a function of degrees from centerline of antenna.

capacity wherever it is needed within the cell without the need for multiple radios or a complex BBU. This technology is called holographic because a pattern of varactor bias states in the antenna control radio frequency waves in the same way that holograms control light waves to produce a 3D image. Altering the DC bias of the varactors changes the impedance seen by the reference wave at each element, thus changing the radiation pattern of the array and directing the beam at a cluster of mobile phone users, or even a single mobile phone user, within the cellular network. All components used in the construction of holographic beamforming antennas are high-volume, low-cost and off-the-shelf, resulting in a much lower cost than MIMO or phased arrays.

Radiators Present Design Challenge

Pivotal Commware engineers use Ansys HFSS to model all microwave components of the HBF antenna. Of particular importance are the element radiators, passive elements of the antenna responsible for the radiation pattern. Radiators present a particular design challenge because they must achieve efficiency over a wide range of frequencies in a compact form factor, smaller than one-fifth of a wavelength.

An example element radiator has a dual-polarized second-order response and is modeled with master/slave boundaries on the sidewalls, two coaxial feeds through an ideal ground plane at $z=0$, and a Floquet port on the top boundary. The element radiator consists of a cross-polarization patch, an inductive grid and a parasitic patch on top. Each antenna array consists of thousands of identical elements; modeling each of these elements would be tedious and require long solution times. So Pivotal engineers use

the HFSS Floquet port with two modes on the $+z$ wall to model an infinite planar periodic structure with elements linked together at their sidewalls. The propagation characteristics of the antenna are set by the frequency, phasing and geometry of the elements. This approach enables fast design iterations by allowing engineers to change the entire model by adjusting a single element, then solve for the new iteration's S-parameters in a fraction of the time required to solve a conventional model.

Engineers parameterize all key design variables in their models. This makes it possible to use the analytic derivatives capability of the Ansys Optimetrics add-on to HFSS to change any design parameter on a tuning dial and instantly update the results plot without having to solve the model again. For example, an engineer

“Pivotal Commware addresses 5G’s new focus on subdividing space with antennas based on holographic beamforming technology.”

moves the analytic derivatives dial to change the thickness of the element by 1 mm. A new dashed curve appears on the radiation efficiency plot that can easily be compared with the original plot to show the impact of the change. Besides radiation efficiency, an analytic derivative simulation also provides the other S-parameters, far fields and first-order analytical derivatives for each design variable in a single simulation run. The magnitude of the partial derivative indicates the sensitivity of the S-parameter to changes in each design variable over the frequency range covered by the simulation.

Using Parametric Sweeps to Study Roll-Off

Engineers also use parametric sweeps to study roll-off in antenna performance as a function of pointing the beam away from antenna broadside. Often, they plot radiation efficiency as a function of frequency of the beamforming direction in 10-degree intervals. These plots typically show near-perfect radiation efficiency at 0 degrees to 20 degrees from centerline, followed by an increasing drop as the antenna is pointed farther from the centerline. Holographic beamforming antennas are still able to achieve reasonable performance at angles of 90 degrees from the centerline.

Previous generations of antenna design engineers used hand calculations to create an initial, highly approximate design, which they gradually improved by building and testing a series of prototypes. Ansys HFSS enables Pivotal Commware engineers to design faster by building a periodic model with a Floquet port that can be solved quickly by using the analytic derivatives tool to dial in the desired performance. They can then run parametric analyses to fine-tune and validate the optimized design. This approach has reduced the time-per-design iteration from a month to a few minutes, making it possible to meet tough performance targets and demanding requirements of cellular providers and mobile phone users in other markets within tight delivery windows. 

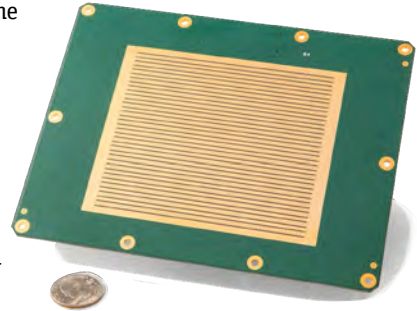

28 GHz antenna for cellular base station

Go Digital with Ansys Advantage

Our online issues contain valuable information including videos and animations.

Subscribe today!
[ansys.com/magazine](https://www.ansys.com/magazine)



Don't miss an issue of Ansys Advantage





COOL Smartphones

Keeping a smartphone from overheating is becoming more challenging as increasing numbers of transistors and devices are made to fit into a small, sleek design. Qualcomm engineers have developed a way to use simulation to create a smaller model of the power sources in a smartphone. This model can be solved in a fraction of the time of a full thermal analysis, so that they can look at more operating scenarios. The goal is to create a dynamic power management strategy to selectively direct power where it is needed and keep temperatures down.

By **Palkesh Jain**, Senior Staff Engineer, Qualcomm, Bengaluru Area, India

As smartphones continue to add features (high-end cameras and antennas) and multitasking capabilities, the additional processing power needed to control these features generates more heat. High temperatures can reduce battery life and accelerate the degradation of interconnects and devices. In addition, a feedback loop can occur in which high processor temperatures lead to high power consumption, which in turn leads to additional temperature increases, in an endless cycle. So smartphone manufacturers must find ways to keep their phones cool.

One solution is to develop a dynamic power management (DPM) strategy that selectively turns off or reduces the power

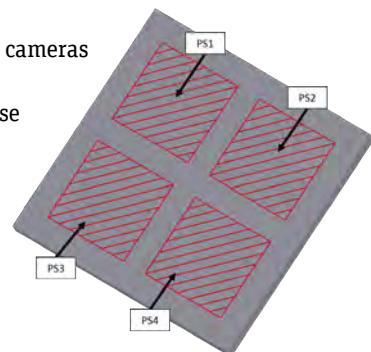

Layout of power sources in main processor

“Qualcomm *engineers* used a simple state-space model in a *simulation* to obtain nearly the same results as a full CFD simulation but 2,400 times *faster*.”

to certain processors until they cool below a specified temperature. DPM strategy requires distributed temperature sensors around the device, especially at critical locations like processors, cameras and antennas. Optimizing a DPM strategy to prevent overheating while maximizing the functionality of the smartphone requires simulation.

Traditionally, Qualcomm has used a full CFD analysis to investigate the transient thermal flow in a smartphone design and investigate possible DPM strategies. But because a full CFD simulation continuously solves for the complete temperature and flow field throughout the smartphone, investigating a single DPM strategy using this method is time-consuming. So Qualcomm engineers began exploring a reduced-order model (ROM) based on linear and time-invariant (LTI) systems and a state-space model that could be solved by simulation in a fraction of the time.

The result was a process that uses Ansys Icepak to perform an initial thermal analysis of the smartphone. The data generated by Icepak was used by the integrated multi-domain systems modeling tool, Simplorer, to create a state-space model – a form of ROM. Simplorer then solved this simplified model in a fraction of the time required for a full CFD method.

LINEAR AND TIME-INVARIANT SYSTEMS

Linearity means that the relationship between the input and the output of the system is a linear map. Time invariance means that whether an input is applied to the system now or sometime in the future, the output will be identical. Most importantly, if two LTI systems have the same step response to a given input, the two systems behave identically. In this case, the two LTI systems are said to be equivalent.

If Qualcomm engineers could show that the thermal model generated by full CFD simulation

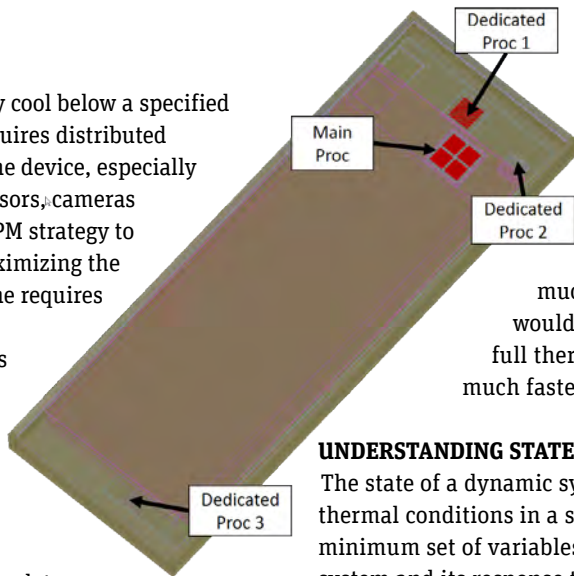

◀ Smartphone layout

and the smaller state-space model were equivalent, solving the much simpler state-space model would be equivalent to solving the full thermal model using CFD, in a much faster time.

UNDERSTANDING STATE SPACE

The state of a dynamic system, such as the transient thermal conditions in a smartphone, refers to a minimum set of variables that fully describe the system and its response to any given set of inputs. These variables are called state variables, and together they define the state space of the system. In a state-space model, knowing the values of these variables at an initial time, along with any inputs to the system at later times, is enough to predict all future states of the system, including outputs. Because the number of state variables is orders of magnitude less than the number of cells in a full CFD analysis, a simulation run using a state-space model can be performed much faster.

For a smartphone, the power dissipated as heat within the processors as a function of time is the system input; the system output is the increase of the chip’s junction temperature as a function of time. Under typical operating conditions, such a thermal system can be approximated as an LTI system.

CASE STUDY

Although a typical cellphone might have about 50 power sources, as a first proof-of-concept trial

Trial		Design variables							
Name	Restart ID	Order	DP1	PS1	PS2	PS3	PS4		
trial001	<input checked="" type="checkbox"/> Select		1	1	0	0	0	0	<input checked="" type="checkbox"/> Set
trial002	<input checked="" type="checkbox"/> Select		2	0	1	0	0	0	<input checked="" type="checkbox"/> Set
trial003	<input checked="" type="checkbox"/> Select		3	0	0	1	0	0	<input checked="" type="checkbox"/> Set
trial004	<input checked="" type="checkbox"/> Select		4	0	0	0	1	0	<input checked="" type="checkbox"/> Set
trial005	<input checked="" type="checkbox"/> Select		5	0	0	0	0	1	<input checked="" type="checkbox"/> Set

Setup to capture step responses using parametric analysis in Ansys Icepak

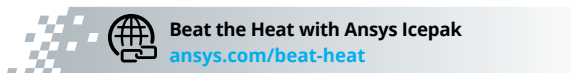

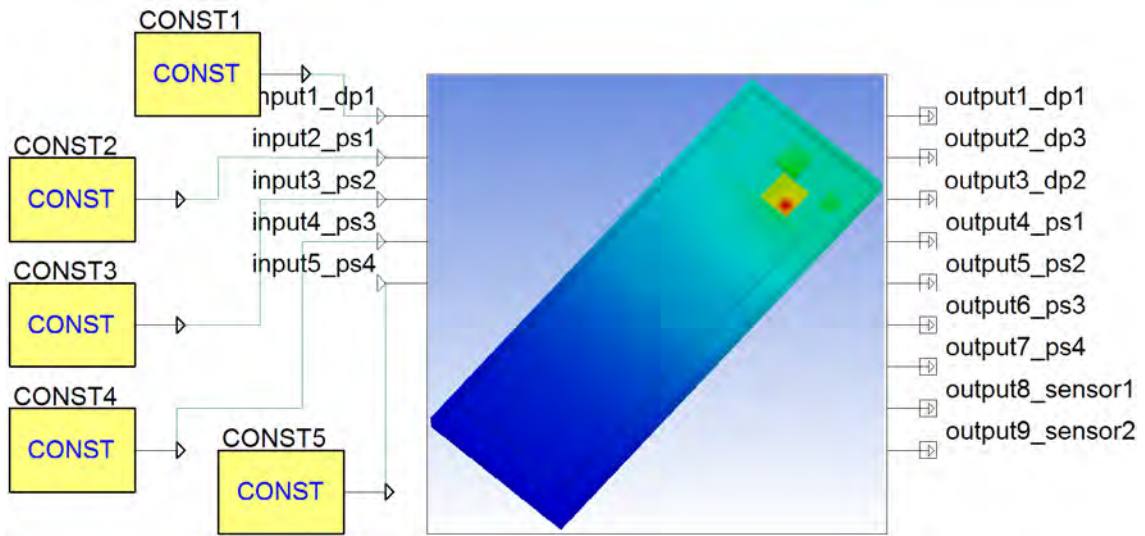

Ansys Simplorer model validation

Qualcomm engineers simplified the model to five power sources: four in the main processor and one in a dedicated processor (such as the one that controls the camera, for instance). These five power source inputs require five Icepak simulation runs, using its parametric capabilities. Using the step response generated from these Icepak simulations, Qualcomm engineers then performed some mathematical calculations to prepare for creating the state-space model, including:

- 1) Calculating the impulse response from the time derivative of the step response.
- 2) Sampling the impulse response curve.

- 3) Performing a fast Fourier transform (FFT) of the sampled impulse response.
- 4) Using the low-frequency portion of the FFT and scaling it in both coordinates to get the sampled Fourier transform of the impulse response.
- 5) Performing vector fitting to obtain the poles and residuals of the transfer function of the state-space model.
- 6) Extracting the state-space model from the transfer function using Simplorer.

After the state-space model was created, engineers applied a constant power of 1.5 watts to the four main processor power sources and 0.1 watts to the dedicated

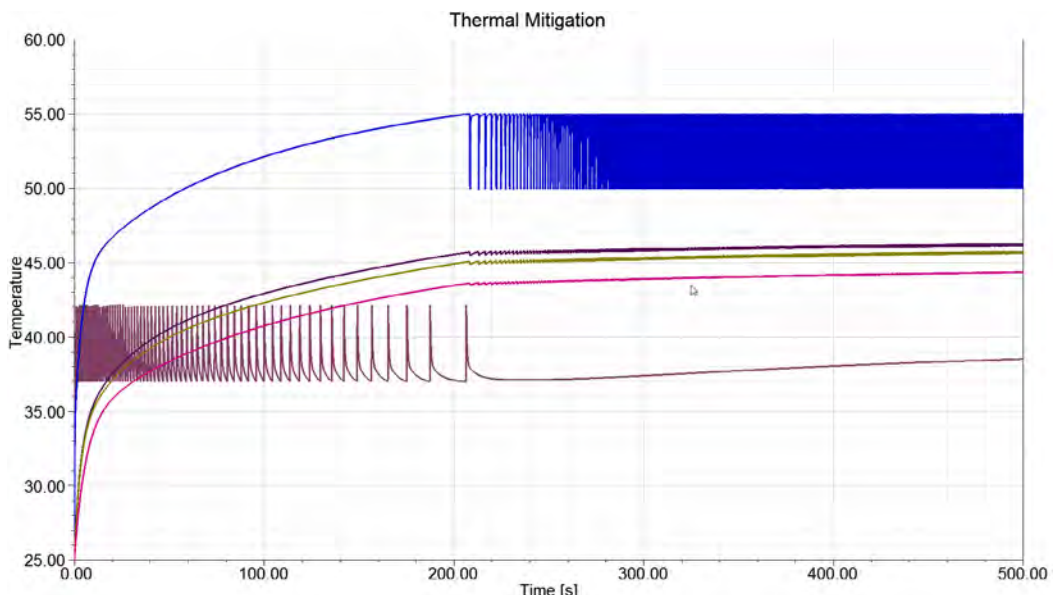

The state-space model results for model with dynamic power management

“By keeping *smartphones cooler*, simulation will extend their working lifetimes, even as more features and *multitasking capabilities* are added in the future.”

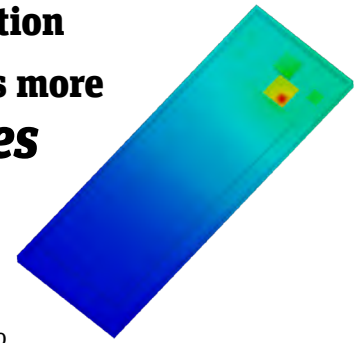

processor. A system-level thermal simulation produced nine outputs corresponding to the junction temperature of all the processors and sensors in the smartphone: one output each for the four main processors; three outputs for the dedicated processor; and two outputs for the two sensors on the chip.

A full CFD run on the complete smartphone model had 1 million computational cells and took two hours to run on eight compute cores. The results of the system-level thermal run on the state-space model with only five inputs and nine outputs took 20 seconds on one compute core. A plot of the two runs shows almost identical results, verifying that the reduced-order state-space model was the equivalent of the full CFD model — an important conclusion, as discussed above.

ANALYZING DYNAMIC POWER MANAGEMENT OF A SMARTPHONE

Because the state-space model can be solved in 20 seconds, Qualcomm engineers were able to study different usage scenarios quickly, which enabled them to investigate more scenarios than before. For the published study, they used a two-point hysteresis element with two power inputs and two thermal outputs to study the DPM of one of the main processors. Setting up a lower temperature limit of 98 C for the output and an upper temperature limit of 100 C, they used Simplorer to simulate a DPM strategy, turning on the power at 1.5 W when the output temperature was 98 C, and shutting off the power input (0 watts) if the temperature reached the upper limit of 100 C. At the same time, the dedicated processor was simulated with a temperature window of 40 C to 45 C and a power input range of 0 watts to 0.1 watts.

The results of the simulation showed that the main processor never reached the upper temperature limit of 100 C in this scenario. The dedicated processor, however, did exceed 45 C. It was never turned back on because the heat from the main processor never allowed

the temperature of the dedicated processor to go below 40 C. Ideally, once engineers have found the optimal power-on duration, they can optimize the chip only for that duration. Alternatively, if a temperature limit is exceeded on a critical power source on the chip, it can be set to a lower frequency and perform at a reduced workload without completely shutting down.

CONCLUSIONS

This investigation showed definitively that Qualcomm engineers can use a simple state-space model in a simulation to obtain nearly the same results as a full CFD simulation. The framework developed can predict the heat dissipation and the location of hotspots under a certain workload, sounding the alarm when temperature limits are exceeded. There is a one-time cost in making the reduced-order model, but once it is available it enables engineers

to explore a lot more what-if conditions. Because the state-space simulation is a factor of 2,400 faster than a full CFD run, they can run many more simulations to fine-tune the DPM of all the power sources in a smartphone. Even though this test case used only five power sources, it will be possible to create a state-space model containing the more than 50 power sources in a working smartphone, and use the integrated system modeling features of Icepak to develop a DPM strategy that may reduce the power input to a specific source but never turn it off completely, so that the phone will retain full functionality, if perhaps not at full speed. By keeping smartphones cooler, simulation will extend their working lifetimes, even as more features and multitasking capabilities are added. ⚠

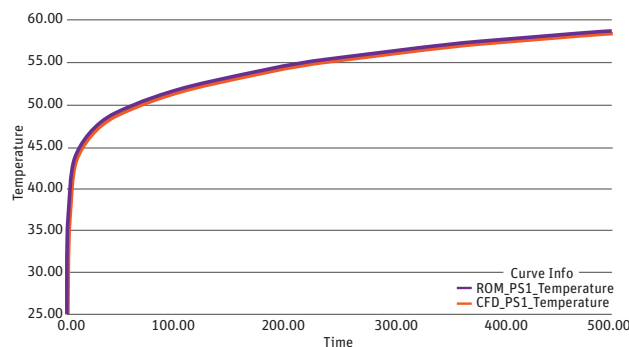

Comparison between Ansys Icepak results and the state-space model results for PS1



Balloon-Borne Vehicles Provide a Bird's-Eye View



It costs hundreds of millions or even billions of dollars to launch a satellite into a geosynchronous orbit where it hovers above a point on earth for observation or communications. Now, World View Enterprises' balloon-borne Stratollite vehicles can carry large payloads to altitudes up to 95,000 feet and park them there for weeks or months at a cost orders of magnitude less than a satellite or other comparable technologies. World View engineers saved an estimated eight months and about \$600,000 by using Ansys simulation software to determine the right design before building and testing a prototype.

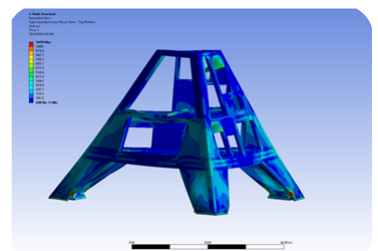

Stresses experienced by payload module during 7g landing

By **Zane Maccagnano**, Lead Engineer, Design Structures & Mechanisms, World View Enterprises, Tucson, USA

The remotely controlled, uncrewed Stratollite vehicle features a payload module carried by a high-altitude balloon. It is a low-cost alternative to rocket-launched satellites for long-duration deployment over customer-specified areas of interest. The Stratollite vehicle maintains its position using a proprietary ballast system that raises and lowers it to capture specific directional wind patterns. It would have cost hundreds of thousands of dollars and taken weeks to build and test each thermal or structural design prototype. Instead, World View engineers used Ansys Mechanical structural and thermal analysis to iterate to a design that meets the company's requirements, achieving validation with just one structural and one thermal prototype.



High-resolution imagery captured during a Stratollite mission over Arizona

OBSERVATION AND COMMUNICATIONS CHALLENGES

There are many commercial and defense applications, such as homeland security, disaster relief, weather forecasting and communications, that require the ability to position sensors on a fixed platform far above the earth, all of which are part of the smart connected world. The conventional method of achieving this

goal has been to launch a satellite into geosynchronous orbit, which is costly and may require years of waiting to secure a launch date. UAVs do provide a more affordable and flexible alternative, but they have limited flight times and are still quite costly to build and operate.

World View's remotely controlled Stratollite vehicle overcomes these limitations by riding a high-altitude balloon to the edge of space at a typical cost of hundreds of thousands of dollars. The Stratollite vehicle carries payloads up to 50 kg and can stay in position for weeks or months, well exceeding the capabilities of current UAVs. Recently, World View successfully executed its first multiday Stratollite mission, a key milestone signaling the commercial readiness of the platform. Admiral Kurt W. Tidd, Commander, U.S. Southern Command, recently said of the Stratollite, "We think this has the potential to be a game-changer for us — a great, long-duration, long-dwell surveillance platform."

SIMULATING MECHANICAL LOADING

Ensuring that the Stratollite vehicle withstands the thermal loading experienced in the stratosphere, as well as the mechanical loading during descent and landing, was a critical part of the design process. Fewer load cases than conventional satellites were required because the payload module does not experience the high vibration and shock loads faced during launch. The greatest mechanical loading

“The Stratollite vehicle carries payloads up to 50 kg and can stay in position for weeks or months, well exceeding the capabilities of current UAVs.”

“Engineers saved up to eight months and about \$600,000 by using Ansys simulation software.”



occurs when the parachute opens during its descent and when it lands on the earth.

The Stratollite payload module frame is built using riveted sheet metal to create a semi-monocoque structure that holds the altitude control and avionics equipment, and the payload. At the bottom of the structure are three skids with energy absorbers used during landing. Testing of the structure under the mechanical loads experienced during descent requires construction of a prototype that can cost hundreds of thousands of dollars and take about three weeks for each design iteration. World View engineers need to ensure that the structure can withstand g-force parachute opening loads of 5 g and landing loads of 7 g. Buckling is the most likely failure mode. The structure also needs to be as light as possible to maximize payload weight.

Through Elite Channel Partner Phoenix Analysis & Design Technologies (PADT), World View joined the Ansys Startup Program, which provides full access to simulation software bundles that are designed and priced specially for startup companies. By working closely with PADT for many years, World View's engineers have gained access to an impressive level of expertise and support, which ensures that Stratollites are designed to withstand the rigors of launching into, flying through and coming back from the stratosphere.

The original geometry of the structure was produced in SolidWorks computer-aided design (CAD) software. Using the Ansys-SolidWorks import tool, World View engineers were able to easily bring the CAD model into Ansys Workbench. Engineers used Ansys DesignModeler to create surfaces from the original CAD file and then, employing Ansys Workbench, generated meshes from the surfaces with computationally efficient shell elements. When the constraints and loads were applied to the structure, the static analysis showed that stresses due to parachute openings, launch loads and landing loads were well within yield limits. World View engineers knew that, with

a semi-monocoque structure, material static strength efficiency is not always the limiting design factor. The thin members, with reduced cross-sectional areas that can lower modulus or stiffness, created design challenges leading to the need for Ansys's advanced capabilities in buckling analysis.

Engineers added a second analysis branch for buckling analysis. They ran the analysis for several buckling modes, which produced the buckling mode shapes and load factors for each mode shape. The buckling load factor is the ratio of the load that will cause the structure to buckle to the actual load — in other words, the margin of safety against buckling. In several cases, load factors were below acceptable levels, so engineers modified the SolidWorks model to, for example, add stringers (ribs with a cross section that are riveted to the structure). They imported the



new geometry from SolidWorks while maintaining the same constraints and loads from the previous version of the model. Over a series of eight iterations, engineers added stringers in the legs above and below the payload, until they were satisfied that the structure could handle the buckling loads. Ansys simulation helped World View add the minimum amount of structural supports to meet their design requirements while minimizing the weight of the structure.

SIMULATING THERMAL LOADING

Thermal loading on the payload module presents electronics thermal management concerns both on the side of the craft heated by the sun and on the cold side, which is exposed to ambient temperatures as low as -90 C . At lower altitudes of about

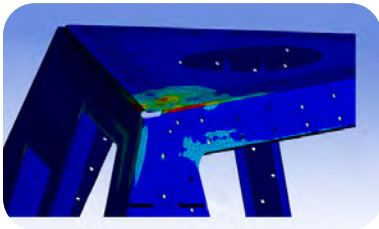

Stresses during a 5 g parachute opening

50,000 feet, the very cold temperatures of the stratosphere can damage electronics, while at higher altitudes of about 95,000 feet, the very thin atmosphere limits convection cooling which can then cause electronics overheating. The electronic equipment in the vehicle must be maintained within the range of -40 C to $+50\text{ C}$. To evaluate the payload module for thermal management, engineers

added geometry to the structure to represent electronic components, including circuit boards, heat sinks, radiator plates and enclosures. They loaded the model with heat sources representing the sun, key integrated circuits and the heaters required to maintain temperatures within the acceptable range. They added conductive pathways and radiant constraints within the enclosure and on its exterior so that the virtual components could be simulated to conduct heat to each other, and to radiate internally and externally. Natural convection of the external surface of the enclosure was calculated using a lookup table to determine the heat transfer coefficient as a function of surface temperatures. With the applied loads and constraints to the model, World View engineers showed that the expected cold case and hot case were within the electronic component temperature limits.

BENEFITS OF Ansys SIMULATION

World View engineers optimized the structural and thermal design with simulation and then performed an iteration of ground testing for mechanical loads and another for thermal loads. In both cases, testing showed that the design met requirements. The recent flight test further confirmed that the design was correct. Simulation saved at least two rounds of structural ground testing, which could have taken about two months and cost around \$300,000, and two rounds of thermal ground testing, which could have taken around six months and also cost around \$300,000. Furthermore, without simulation, the structure would have been considerably heavier, reducing the payload capacity of the vehicle. 🚀

“Without simulation, the structure would have been considerably heavier, reducing the payload capacity of the vehicle.”

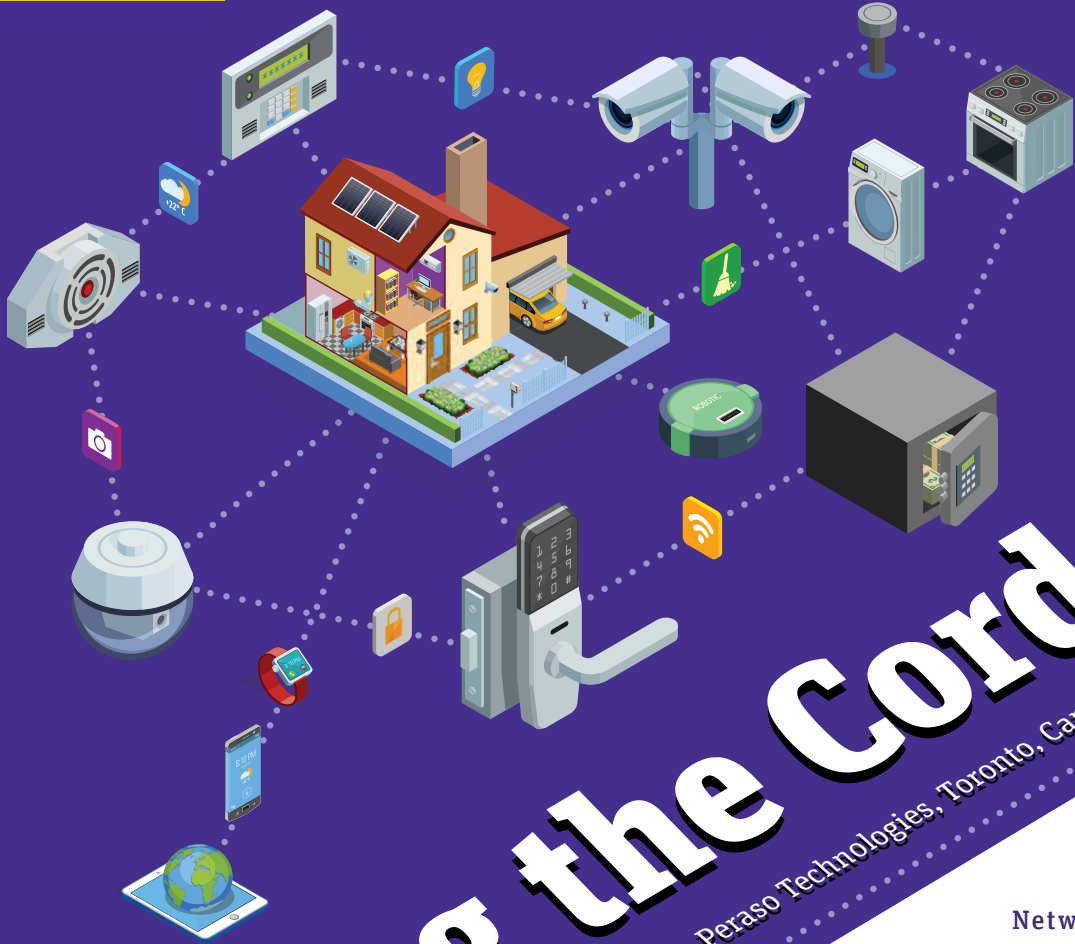

Cutting the Cords

By Dori Itzhaki, IC Package & Board Design Expert, Peraso Technologies, Toronto, Canada

Networking experts predict that, by 2021, 66 percent of all internet traffic will be used for high-throughput services such as wireless docking, video streaming, cloud backup and virtual reality. Peraso Technologies enables users to cut the cord and go wireless by providing chipsets based on the emerging 802.11ad (WiGig) standard that delivers high-speed wireless throughput in a USB 3.0 stick form factor. Peraso engineers used Ansys simulation software to solve thermal problems associated with packing high-power transmitters into a tiny enclosure.



Early design of enclosure modeled in Ansys SpaceClaim

TODAY'S STATE-OF-THE-ART HIGH-SPEED DATA INTERFACES, such as docking stations, 4K video streaming, virtual reality headsets and other similar products, commonly require wired connections to avoid data bottlenecks. The multigigabit speed of Peraso's W120 WiGig chipset enables users with a SuperSpeed USB 3.0 port to simply plug in a USB stick to achieve multigigabit speeds that are fast enough so that users can cut the cord on high-speed interconnect applications. One of the greatest challenges in designing a USB 3.0 WiGig adapter based on the W120 chipset was dissipating the heat generated by the adapter within a tiny enclosure that is similar in size to a typical thumb drive. Peraso engineers overcame this challenge using Ansys multiphysics simulation to accurately predict temperature and heat flow at every point in the adapter as they iterated its design. Simulation reduced the time required for thermal design by two-thirds.

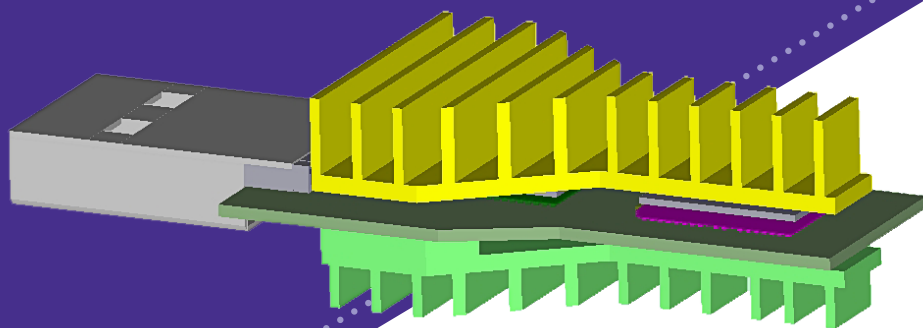

◀ Ansys Icepak model of interior components of the adapter shows: top heatsink (yellow) connected to 115 C-rated components, bottom heatsink (light green) connected to PCB, one of 115 C-rated components (red), PCB (green) and USB connector (gray).

THERMAL DESIGN CHALLENGE

WiGig is a new wireless networking standard from the Wi-Fi Alliance that adds a third 60 GHz band to the existing 2.4 GHz and 5 GHz bands of Wi-Fi to enable extremely high data rates, lower latency and dynamic session transfer in multiband devices. Peraso's new W120 chipset provides a high-speed USB 3.0 to WiGig solution that enables blazing fast high-throughput wireless connectivity for a host of applications that require more bandwidth than Wi-Fi can deliver. In designing a complementary USB 3.0 WiGig adapter, the conflicting requirements for high-power transmitters and a compact, cost-effective enclosure created a thermal challenge for the system's designers.

The W120 WiGig adapter includes two main chips that dissipate considerable heat and a number of other active and passive components, all mounted on a printed circuit board (PCB) with traces that produce Joule heating effects. The two main chips that dissipate most of the heat in the adapter are rated to 115 C junction temperature, while the other components on the PCB are only rated to 85 C. Because heat dissipation in a small enclosure is very difficult to achieve, the most cost-effective way to cool the adapter would be to maintain the chips and PCB near their respective maximum temperatures. Engineers explored several thermal design options, and concluded that their solution should employ a large heat sink connected to the two chips but not to the PCB, and a smaller heat sink connected to the PCB but not to the two chips.

In creating the thermal design, engineers needed to identify the sweet spot, where just enough heat was removed from the chips to allow them to perform at acceptable levels while keeping the PCB at a cooler temperature. This entire structure had to be enclosed in a case with limited openings. The case interferes with free air flow, so optimizing its shape was imperative to achieving efficient and effective thermal cooling. Had engineers used traditional build-and-test methods, they would have had to guess at how heat was transmitted through the adapter. In particular, their inability to measure airflow inside the unit would have made it very difficult to determine how to fix problems identified in physical testing.

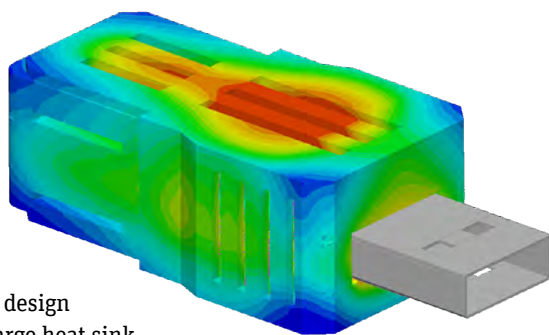

Temperature of the adapter with enclosure openings oriented along length of adapter

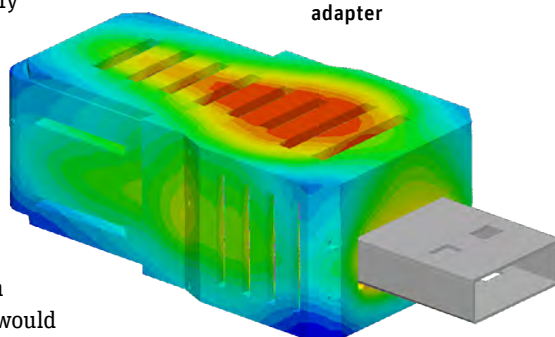

Temperature of the adapter with enclosure openings oriented along width of adapter



Temperature plotted on airflow streamlines around the adapter without an enclosure using Ansys Icepak

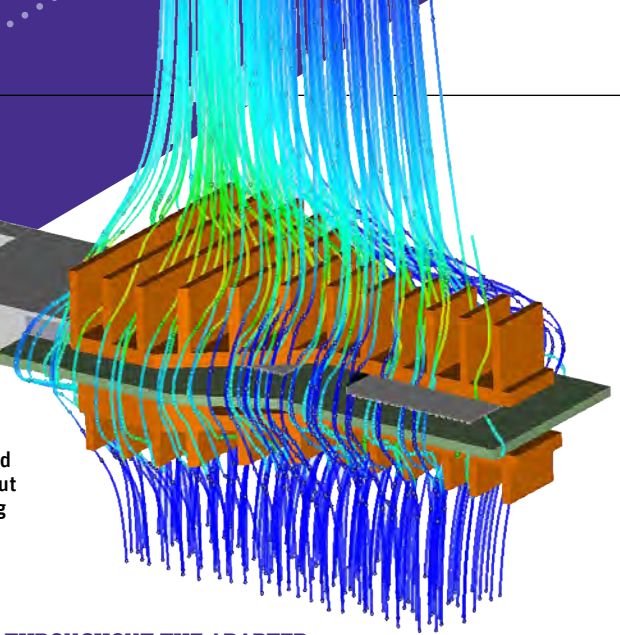

SIMULATING TEMPERATURE THROUGHOUT THE ADAPTER

To address these challenges, the team used Ansys SIwave electromagnetic field solver to capture the Joule heating effects. The resulting heat map was transferred to the Ansys Icepak thermal analysis tool where the current flow heat was combined with all the other thermal effects for a comprehensive thermal analysis. This enabled Peraso engineers to accurately predict heat distribution and temperature at every point in the inner electronics of the adapter. They also

“Simulation enables engineers to explore thermal management solutions in much less time than was possible in the past.”

modeled the electronic components in Icepak using predefined building blocks and defined the active components as heat sources. To design the heat sink's structure and the enclosure for the adapter, they created the geometry of an initial design using Ansys SpaceClaim and imported it into the Icepak module. Icepak used all

the information revealed by the electronics simulation to evaluate the orthotropic thermal conductivity of the PCB and compute the temperature at every point in the solution domain.

The simulation results showed the temperature of the components rated at 85 C was too high. The problem was largely caused by heat leaking from the two main components through the PCB to the 85 C-rated components. To tackle this problem, they modified the design of the board to balance

the thermal conductivity between the top and bottom layers and steer the heat dissipation in the right direction. They also changed the ratio of the size of the two heat sinks. Several iterations were required to achieve the right heat transfer balance between the devices and the PCB.

After the right balance was found, the engineers added the enclosure element into the design. The enclosure negatively affected the heat flow around the board and heat sinks, so they had to provide some openings in the enclosure. The engineers focused on finding the right configuration of openings in the enclosure that would create minimal disturbance to the airflow through the adapter and reduce the loss in the convective heat transfer from the heat sinks to ambient. The overall area of the openings in the enclosure is limited by structural considerations, but engineers had considerable flexibility in positioning these openings.

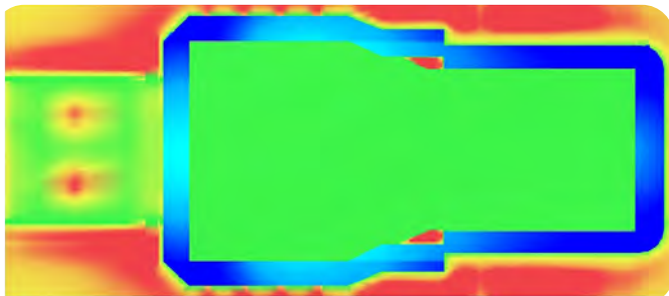

Temperature plotted across cross section of adapter aligned with PCB showing hot spots (red) where flow is constricted by narrow gaps between PCB and enclosure

ITERATING TO AN OPTIMIZED DESIGN

To continue their thermal optimization, the team modified the design of the enclosure numerous times in SpaceClaim and reran the simulation, using the simulation results to guide them as they iterated toward an optimized design. The advantage of using SpaceClaim is that the user can push, pull and rotate faces on solid models while all of the nearby geometry adjusts in real time without having to consider parametric constraints. To understand how air naturally flowed around the electronic components, the engineers simulated the electronics without an enclosure. Then they created a new enclosure design in SpaceClaim to position the openings in the areas where airflow was the highest. They simulated the new design, and the results showed improved heat dissipation.

Engineers wondered whether orienting the openings along the length or along the width of the adapter would be more effective. So they created two versions of the enclosure, with the openings oriented widthwise in one and lengthwise in the other, and ran a new simulation on each. The results showed that orienting the openings along the length of the adapter was more effective. The team created additional design iterations to evaluate other opening configurations, reducing the temperature of the PCB to the point where it nearly met the specification. Engineers were briefly stumped as to how to get over the finish line when one of them had the idea of viewing flow velocity over a cross section aligned with the PCB. The results showed that flow was



“Engineers used Ansys multiphysics simulation to accurately predict temperature and flow at every point in the adapter as they iterated its design.”

constricted in a small area near where the PCB came close to bumping up against the enclosure. They reduced the size of the PCB slightly to free up flow in this area, and the temperature of the PCB dropped to the level needed to meet the spec.

This application provides an excellent example of how simulation enables engineers to explore thermal management solutions in much less time than was possible in the past when physical testing was the primary design tool. Physical testing provides temperature measurements at a few key points, which is enough to determine the effectiveness of a proposed design, but it usually provides little guidance on how the design needs to change to meet the spec. Engineers estimate that with physical testing alone it would have taken three to six months to meet the temperature spec on the USB-3 adapter. Using Ansys simulation tools, on the other hand, provided temperatures, flow velocities and pressure at every point in the solution domain. This diagnostic information guided engineers in quickly improving the thermal design of the adapter. As a result, in just one month engineers were able to meet the design specification by reducing the temperature of the PCB by 7 degrees. 🚀

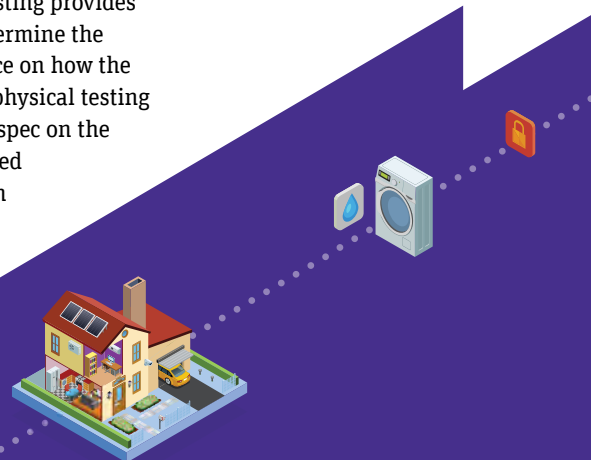

Brain Trust for Aneurysm Treatment

By **Mathieu Sanchez**, Chief Executive Officer, Sim&Cure, Montpellier, France



TO PROVIDE EFFECTIVE TREATMENT FOR BRAIN ANEURYSMS, a pioneering healthcare company has developed a digital twin to help physicians place implant devices during surgery. Incorporating Ansys structural mechanics solutions, the surgeon can simulate the deployment of the implant and determine its optimal sizing and positioning to decrease the risk of failure and reduce operating times.



Medical devices can be tested using three methods – within the body (in vivo, left), outside the body (in vitro, center) and within a computer (in silico, right).

Approximately 2 percent of the population has a brain aneurysm, an enlarged section of an artery caused by a weakening of the arterial wall. Although most show no symptoms or have no health problems, about 1 percent of these aneurysms rupture every year, and about 30 percent of ruptures result in death. Small aneurysms with a low probability of causing damage are often managed simply by tracking their size. One way to treat larger aneurysms is to surgically open the brain, remove the diseased section of artery and clip the remaining ends together. Retrospective analyses have found that surgical options are associated with a higher risk of bad outcomes, longer hospital stays and longer recovery times compared with endovascular procedures. In an endovascular procedure, a catheter is inserted into an artery of the leg near the groin. Aided by medical imaging, the surgeon guides the catheter, which carries the implant, to the aneurysm. Once the device is in position, the surgeon expands the implant and removes the catheter.

Several types of endovascular implants are used to treat brain aneurysms, including flow diverters (FDs), intrasaccular devices (IDs) and laser-cut stents. According to the Cardiovascular Research Foundation (CRF) and the National Center for Biotechnology Information (NCBI), selecting an implant with the right diameter, length and expansion to closely fit the cross section and length of the aneurysm is of paramount importance in achieving the best outcome for the patient. Papers published by the NCBI indicate that up to 65 percent of endoscopic procedures are characterized by various types of geographic miss. For example, if an ID implant designed to deploy inside the aneurysm sac is too small, blood can fill the gap and apply pressure on the aneurysm. Oversizing of the implant could lead to the creation of a clot and an ischemic stroke.

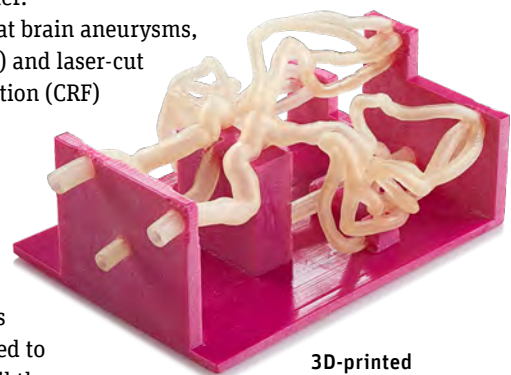

3D-printed model of arterial network in brain

Sim&Cure's solution to this involves the generation of a digital twin. While the patient is under anesthesia, the surgeon runs software that incorporates a model of the structure and behavior of the patient's damaged blood vessel. The software quickly and accurately helps physicians to define the optimal size of the implant and where it should be positioned to give the best results.

Current Methods for Implant Sizing

Physicians have traditionally used one of two methods to size and position the implant. One approach is to perform measurements on 2D scans captured as part of 3D rotational angiography, or measurements of the 3D scans themselves, just before surgery. This takes at least 10 minutes, so it lengthens the time the patient must be under anesthesia, increasing the risk of complications. These measurements do not account for the deformation and movement of the implant during the procedure, so effective deployment depends upon the skill, experience and intuition of the individual physician.

Another approach is to employ 3D rotational angiography to produce a computer-aided design (CAD) of the blood vessels. Then a 3D printer slowly builds a physical model of the blood vessels, which is used to test different device sizes and deployment factors. But the drugs used during the procedure significantly alter the size and shape of the artery, so the model builders must try to estimate these effects. Actual conditions may vary from the physical model that was used to size the implant.

Simulation Software Provides a More Accurate Solution

In Sim&Cure's new method, 3D rotational angiography is used to produce a 3D model of the aneurysm and surrounding blood vessels after the patient is prepped for surgery. Sim&Cure's software imports the model of the artery and presents it to the surgeon, who selects points on the artery that define the ideal final position and deployed size of the implant.

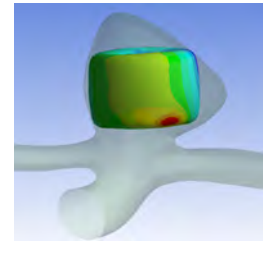

“Sim&Cure is the first company to be cleared to market a patient-based digital twin incorporating simulation for aneurysm treatment that includes expansion and deployment of implants based on the patient’s unique arterial geometry.”



Arterial system with aneurysm viewed with 3D rotational angiography

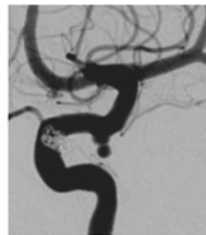

Arterial system with aneurysm (circular protrusion from artery) viewed with 2D axial angiography

Sim&Cure's IDsize® software simulates intrasaccular device implants incorporating models of a wide range of sizes of the available implant devices so the surgeon can select the specific implant that he or she wishes to simulate. Sim&Cure combines the model of the patient's arteries with a model of the selected device and produces an Ansys Mechanical input file. Ansys Mechanical analyzes the deformation of the device and arteries, along with their interaction with each other, and provides a 3D model of the device deployed in the patient's artery that shows the implant and the aneurysm superimposed on each other.

The physician can translate, rotate and zoom the image to fully understand the relationship between the implant and the aneurysm. Color coding can be used to show the exact area where the implant touches the embolism (blockage). A cross-sectional profile indicates any gaps between the implant and the artery. Each simulation takes only 10 to 25 seconds, depending on the device that is selected. The surgeon can easily select and simulate additional devices and sizes for analysis in order to determine which one will provide the best results. In less than five minutes, the surgeon can complete the simulation process, select the optimal device and begin the operation.

Clinical Trial Results are Positive

Normally, about 10 percent of endovascular treatments require follow-up surgery, usually because of issues with the sizing or positioning of the implant. But in more than 500 surgeries conducted in three clinical trials with Sim&Cure’s software, follow-up surgery has never been required for a single patient.

In many aneurysm surgeries, a second or even a third implant may be required, usually because the one that was originally selected turns out to be the wrong size when inserted into the patient. This results in a longer surgery and increases the risk of complications to the patient. Doctors who used Sim&Cure software have reduced the number of devices used per surgery from 1.35 in the past to only 1.05 now. Besides reducing the risk to the patient, this saves 3,000 euros (approximately US\$3,600) per operation. The trials also show that Sim&Cure reduces the time required to perform surgery by about 30 minutes, which further reduces the risk of complications and provides additional cost savings.

“Ansys Mechanical analyzes the deformation of the device and arteries, along with their interaction with each other, and provides a 3D model of the device deployed in the patient’s artery.”

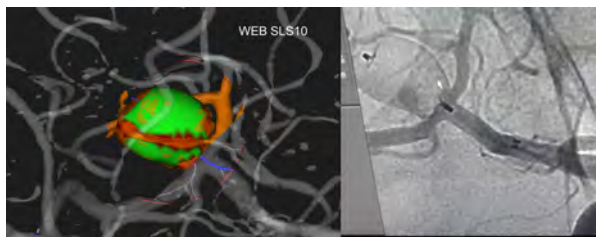

Ansys Mechanical simulation of implant deployed in aneurysm (left). The surface of aneurysm that abuts the implant is shown in green. Simulation results accurately predicted implant deployment, resulting in successful intervention.

Sim&Cure engineers selected Ansys Mechanical for this application for several reasons. They wanted to avoid the time and resources that would be required to develop their own finite element analysis software, and they wanted the package with the highest level of accuracy and the strongest reputation in the medical field. Ansys Mechanical filled both requirements. The Ansys customer excellence team in Europe worked closely with Sim&Cure engineers to help ensure a fast and seamless integration.

Sim&Cure is the first company to be cleared to market a patient-based digital twin incorporating simulation for aneurysm treatment that includes expansion and deployment of implants based on the patient’s unique arterial geometry. Clinical trials conducted in three European hospitals have shown a significant reduction in follow-up surgeries and in surgery duration. Sim&Cure’s solution is now being used in 17 different countries with expectations that it will be used in more than 2,000 surgeries by the end of this year. ¹

Histogram of Implanted Nominal Length

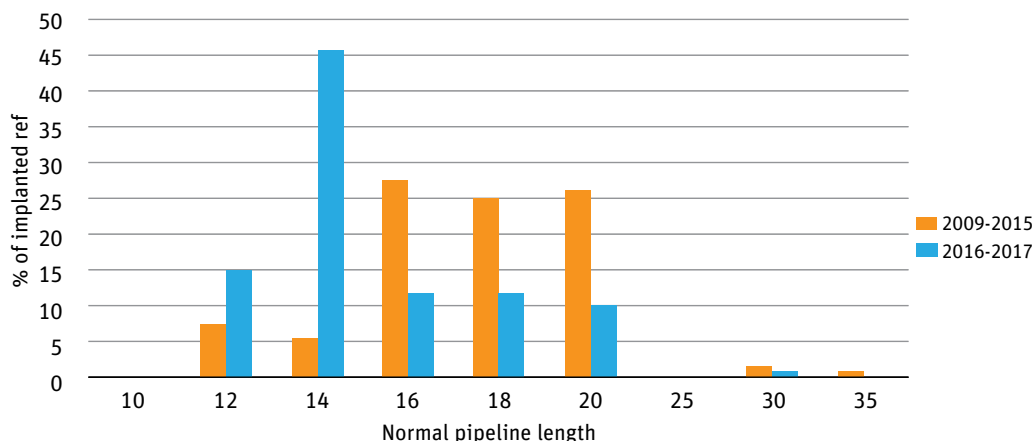

Histogram shows how use of Sim&Cure software in 2016–2017 made it possible to use smaller implants than were employed previously, reducing risk of complications.

Breaking Story on an Automotive Power Module

All cars now depend on electronics that must work reliably. When a new power steering module failed under testing, engineers at Integrated Micro-Electronics were faced with spending eight months using trial-and-error to determine the cause and find a workable solution. Instead they used Ansys structural capabilities, including contact analysis, transient thermal analysis, and linear and nonlinear thermomechanical buckling analysis, to develop a reliable module in half the time.

By **Christian Esguerra**, Design Engineer, Integrated Micro-Electronics, Inc., Manila, Philippines

The power module is an electronic component in most modern automobiles. It contains inverters that convert low-voltage direct current power from the battery to high-voltage alternating current to drive the electric motor that steers the vehicle. This process generates heat that must be removed to avoid exceeding the junction temperature of the inverters. Most electronic power modules must pass reverse polarity testing to ensure against mishaps during installation of a new battery, reconnection of the original battery after repairs, or a jump-start. In the reverse battery test (RBT),

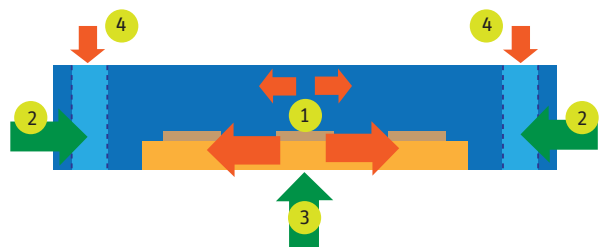

Forces during the reverse battery test:
1) expansion of substrate, 2) reaction forces exerted by bolts, 3) reaction to bolt preload and 4) bolt forces

“Without *simulation*, it would likely have taken at least eight months to *solve the problem*, and the contract might have been lost.”

input polarity is reversed and the inverters behave like short circuits, drawing about 140 amps and generating much more heat than in normal operation.

Integrated Micro-Electronics (IMI) is the sixth largest provider of electronic manufacturing services to the global automotive industry and a major player in many other markets. The company’s engineers found that a power steering power module frequently cracked down the centerline of the epoxy molding compound (EMC) package and experienced solder remelting during the reverse battery test. With multiple design variables, a large design of experiments that would take up to eight months would have been required to diagnose and solve the problem. Instead, engineers used cross-platform, multiphysics analysis to understand what caused these problems and solved them in only four months.

Reverse Battery Test

The power module contains nine metal oxide semiconductor field effect transistor (MOSFET) inverter chips that dissipate the bulk of the current. The direct bonded copper (DBC) substrate is made up of three layers consisting of, from the top down, copper, ceramic and copper. DBC combines the high thermal conductivity of copper and the low coefficient of thermal expansion of ceramic. However, the mismatch in coefficient of thermal expansion between copper and ceramic causes slight warpage, creating a concave shape on the bottom of the module that is expensive to eliminate. A screw and bolt on each side fastens the package to a heat sink that is part of the motor subframe. A thermal interface material (TIM) pad with high thermal conductivity provides electrical insulation between the substrate and the heat sink.

As the module heats up during the RBT, the whole package expands against the bolts and is subjected to in-plane compressive reaction forces. An upward force is generated on the module in response to the bolt preload. Heat softens the EMC, leaving just the DBC substrate to resist compressive forces exerted by the bolts. When the substrate can no longer resist, the package buckles upward. This much was clear at the beginning of the troubleshooting process. But with

many different design variables to consider, IMI engineers faced a long and expensive process using the design of experiments method to guide the many physical experiments required to understand the impact of each design variable and solve the problem.

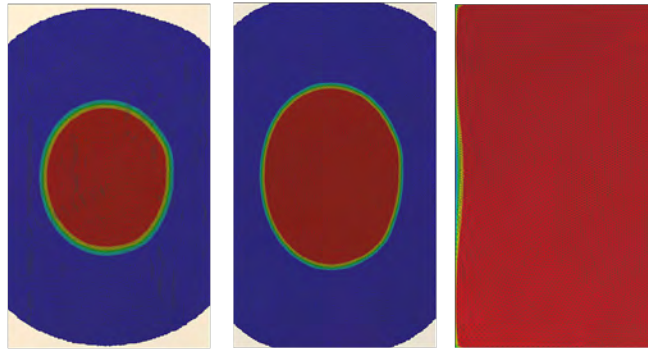

Results of contact analysis simulation with red areas indicating sufficient contact pressure to enable thermal conduction with design parameters of (left) 200 μm warpage, 100 μm TIM thickness and 800 N bolt force; (center) 60 μm warpage, 500 μm TIM thickness and 800 N bolt force; and (right) 60 μm warpage, 500 μm TIM thickness and 1200 N bolt force

Simulating the Test

After considering the high cost and lead time involved in performing these

physical experiments, engineers decided to simulate the RBT with Ansys Mechanical software. As a first step, they needed to know the power dissipation through each of the nine MOSFETs, which are grouped as three transistors for each of the three alternating current (AC) phases. They performed an electrical simulation that showed that 80 percent of the current goes through the AC phase nearest the input. Approximately 15 percent was shared by the middle phase, and the farthest phase dissipated the final 5 percent.

IMI engineers then created an Ansys Mechanical model of the substrate, package, TIM pad, heat sink (subframe) and bolts. They then applied preload to the bolts to predict the effective thermal contact area



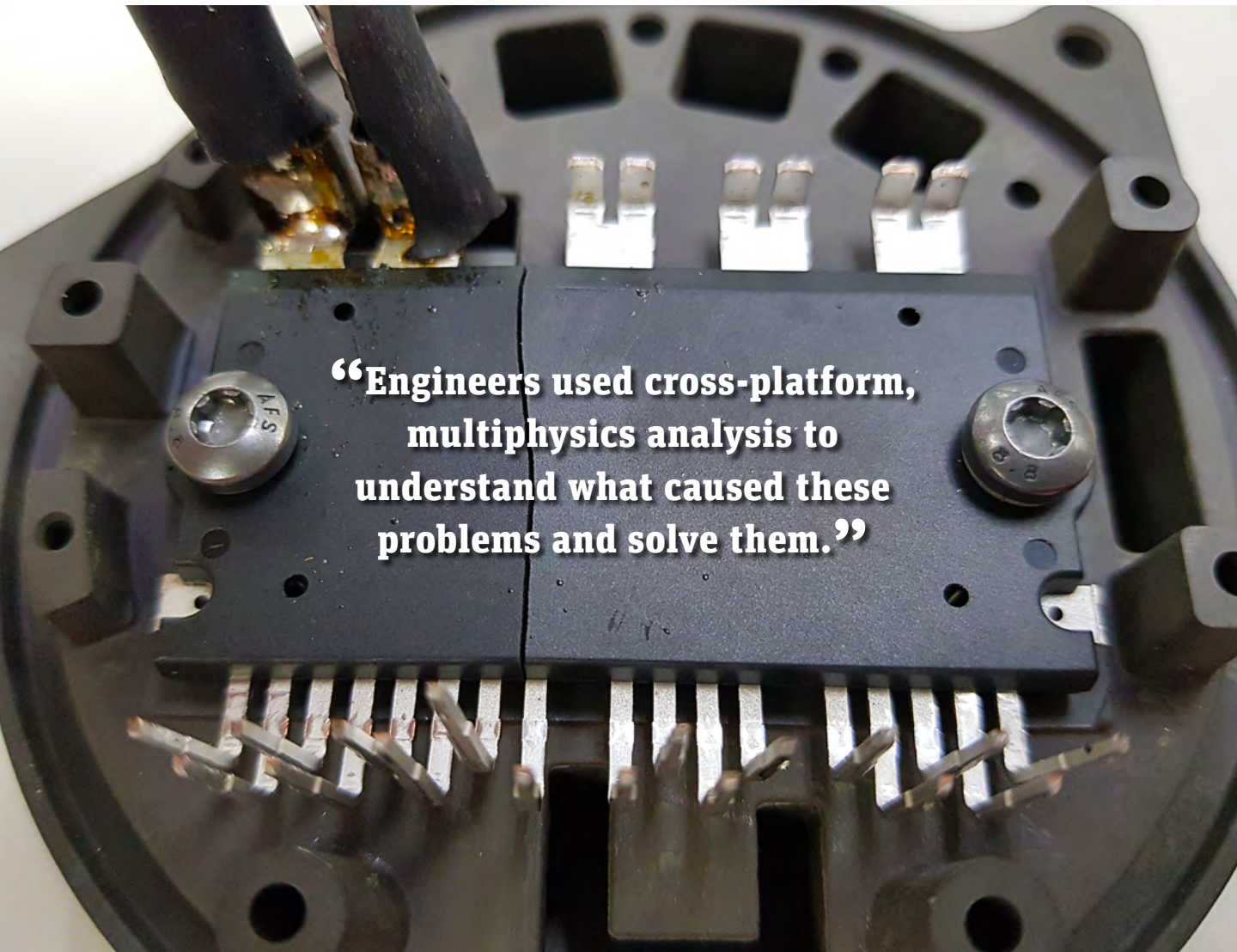

“Engineers used cross-platform, multiphysics analysis to understand what caused these problems and solve them.”

between the power module, the TIM and the heat sink. The contact area determines the amount of heat transferred to the heat sink, so it has an impact on the temperature of the module. Engineers ran a parametric analysis to determine the sensitivity of contact area to the bolt force, warpage of the package and thickness of the TIM. The contact area varied between 18.7 and 97.8 percent for the simulated cases. The results showed that contact area generally increases with decreasing module warpage, increasing bolt force and increasing TIM thickness. A high bolt force, thick TIM pad and small module warpage provided nearly 100 percent contact.

The next step was a transient thermal analysis with the electrical simulation providing the heat sources and the contact analysis determining the effective thermal contact between the module and the heat sink. Engineers ran another parametric analysis, using the same values of the same variables that

were used in contact analysis. The results showed that generally the design parameters that produced higher contact areas also generated lower junction temperatures. In most of the simulated cases, the temperatures exceeded the solder reflow temperature. Only in cases with low warpage, thick TIM pads and high bolt forces could the module be expected to avoid solder remelting during the RBT.

Next, IMI engineers used the loads from the previous mechanical and thermomechanical analyses as prestress for a linear buckling analysis. They used the perturbed shape from linear buckling as a starting point for nonlinear buckling. The nonlinear buckling simulation accurately predicted the cracking

“Simulation helped to *develop a solution* that did not increase manufacturing costs – in about *half the time* that would have been required using physical experiments alone.”



Setup of thermal contact deformation analysis for final design

seen in physical testing with the starting design parameters of 100 μm TIM pad thickness, 800 N bolt preload and 60 μm warpage. The simulation showed that buckling could be eliminated by reducing bolt force. But the transient thermal analysis showed that this would increase temperature to the point that solder remelting would occur. A hypothetical perfect package with zero warpage, 800 N bolt load and 100 μm thick pad would not buckle and would not remelt the solder. But this perfect package would require considerably higher manufacturing costs, which were unacceptable.

SOLVING THE PROBLEMS

Understanding the cause of the problems and their sensitivity to the relevant design variables, IMI engineers explored the idea of switching from a TIM pad to a TIM gel. The advantage of the TIM gel is that it maintains a greater contact area at lower bolt forces, enabling the bolt force to be reduced without causing solder remelting. The simulation showed that these changes would solve both the buckling and the solder remelting problems. Engineers built and tested a prototype, and the results matched the simulation.

Without simulation, it would likely have taken at least eight months to solve the problem, and the contract might have been lost. With simulation,

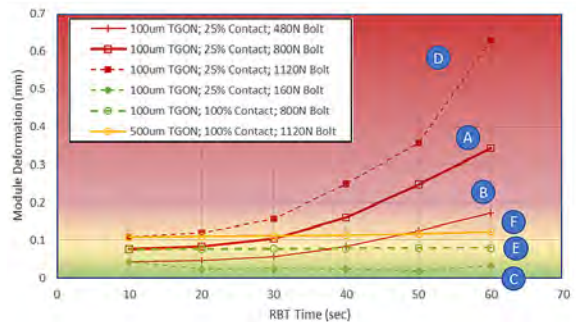

Nonlinear buckling analysis results with area colored red indicating cracking failure and area colored green indicating no cracking. Case C has little deformation but fails due to solder remelting. Case E has little deformation and a low temperature but could not be produced with the existing manufacturing process. Case F provides acceptable levels of deformation and temperature, but with no margin of safety, so even small levels of manufacturing variation could cause failures.

Integrated Micro-Electronics engineers quickly diagnosed the two problems of solder remelting and module cracking, and determined sensitivity to the relevant design variables. Simulation helped engineers to develop a solution that did not increase manufacturing costs – in about half the time that would have been required using physical experiments alone. **A**

DBC Warpage (μm)	TGON Thickness (μm)	Tj @ RBT 60s (°C)		
		Bolt Force (N)		
		480	800	1120
200	100	318.0	302.1	281.0
	300	311.4	289.6	271.6
	500	312.8	277.3	248.0
120	100	310.7	289.7	265.1
	300	300.2	265.6	235.5
	500	305.4	259.9	223.1
60	100	277.4	254.5	225.0
	300	290.5	220.5	184.7
	500	310.4	214.9	176.5

Transient thermal analysis results with red indicating solder remelting will occur, green indicating solder remelting will not occur and yellow indicating borderline results

AIMING HIGH

By **Eric Besnard**
 Chief Technical Officer
 Vice President of Engineering and Co-Founder
 Vector, Tucson, USA

MICROSATELLITES represent a new opportunity to provide connectivity for the Internet of Things, as well as to capture images and data from space, at a relatively low cost — but the challenge is getting them into orbit in a timely and cost-effective manner. By making satellite launches both routine and affordable, startup Vector is opening up the space race to a new generation of small and mid-sized businesses that can deploy entire swarms of tiny satellites. With its risk-taking engineering strategy, Vector is poised to disrupt the satellite industry, one launch at a time.

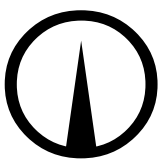
nce the domain of large companies and oversized technology, the satellite industry is evolving in exciting ways today in response to a huge, and growing, market for satellite capabilities. The growing Internet of Things (IoT) demands new levels of global connectivity, autonomous vehicles require GPS positioning data, and concern about climate change means that weather conditions on Earth must be continuously monitored.

A new generation of microsats — some measuring only 10 centimeters across — has emerged to answer this need, providing uninterrupted connectivity and information capture more affordably than previous technology. These tiny, lightweight satellites are ideally suited to meeting a number of urgent market needs. Deployed in swarms, they provide a powerful solution by enabling communication and supporting data capture and exchange around the world.



While it's relatively inexpensive to manufacture these small satellites, the final frontier is sending them into orbit affordably. The prohibitive cost of traditional launch technology — as well as long wait lists for a launch date — are currently keeping small and mid-sized businesses from entering the growing microsatellite market. While these businesses can manufacture thousands of tiny satellites, they cannot afford to wait years to launch them.

A NEW INDUSTRY SEGMENT TAKES OFF

Recognizing this market need, Vector was founded in 2016 to design, engineer and manufacture rockets capable of sending customers' microsatellites into orbit. The executive team includes a co-founder of SpaceX, as well as a number of experts who have worked at NASA, Virgin Galactic and other aerospace leaders. The Vector team also brings together a wide range of experience in software and high-technology, engineering, rocket science and business management.

Small to mid-sized businesses must wait for an opportunity to "hitchhike" on a larger launch mission as a secondary or tertiary payload. Vector is aiming to change that by offering dedicated, frequent, reliable launches. With no competition in the microsatellite launch category — defined as payloads of 60 kilograms or less — Vector sees a unique opportunity to create and then dominate this new industry segment.

FIRING UP INNOVATION

The key to success for the Vector team is quick development and commercialization of the complex technology systems needed to accomplish this goal. Both the launch system and the rocket push the boundaries of physical performance, because significant stresses are placed on every system and subsystem involved. Components in the rocket must withstand speeds in excess of Mach 6, along with temperature variations ranging from -160 C to 3,000 C. All electronics must be miniaturized to keep the rocket small and lightweight, increasing the technical complexity.

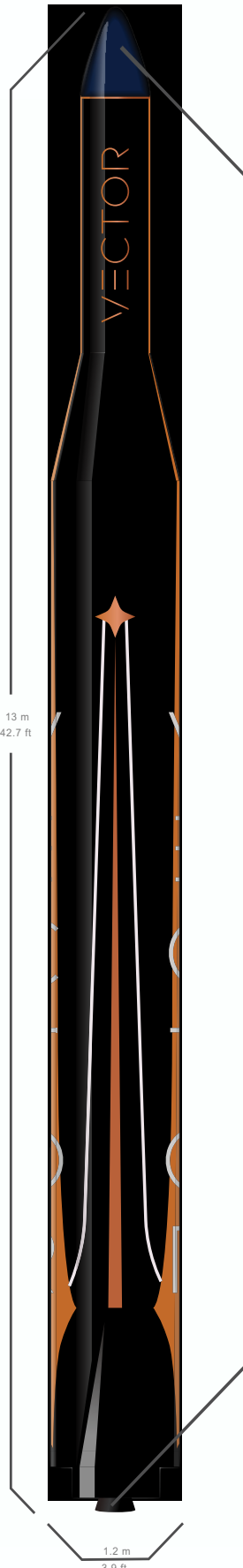

While NASA and other large aerospace concerns have generous budgets devoted to research and development, Vector was funded with just \$21 million in venture capital. In order to sustain itself and support its future profitability, Vector must keep its team small, minimize development costs and get its products to market as soon as possible. This means implementing a number of new-generation engineering practices.

Engineering simulation represents a critical way for Vector to dramatically cut the time and financial investments required to develop its launch systems. By using a unified set of multiphysics simulation tools acquired via the Ansys Startup Program, Vector developers can design products in a virtual space, exploring a range of engineering problems across the launch system.

For example, fluids simulation software enables the Vector team to study the rocket engine's internal flows, which are associated with propellants, reacting gases in the combustion chamber and heat loads on the hot chamber walls. Mechanical simulations reveal how the rocket will respond to the huge environmental changes it will have to endure, including extremely high structural, mechanical and thermal stresses.

The combined rocket-launcher system has an enormous degree of numerical complexity. Simulation supports Vector's engineering team as it seeks to bring all those pieces together successfully. Using design exploration, product developers can change parameters very quickly and see how the entire system will respond.

This greatly accelerates the iterative design process and allows the Vector team to arrive rapidly at a rocket and launcher that have a high degree of robustness — before the construction of a physical prototype, which can take months.



“Engineering *simulation* represents a critical way for Vector to dramatically *cut the time* and financial investments required to *develop* its launch systems.”

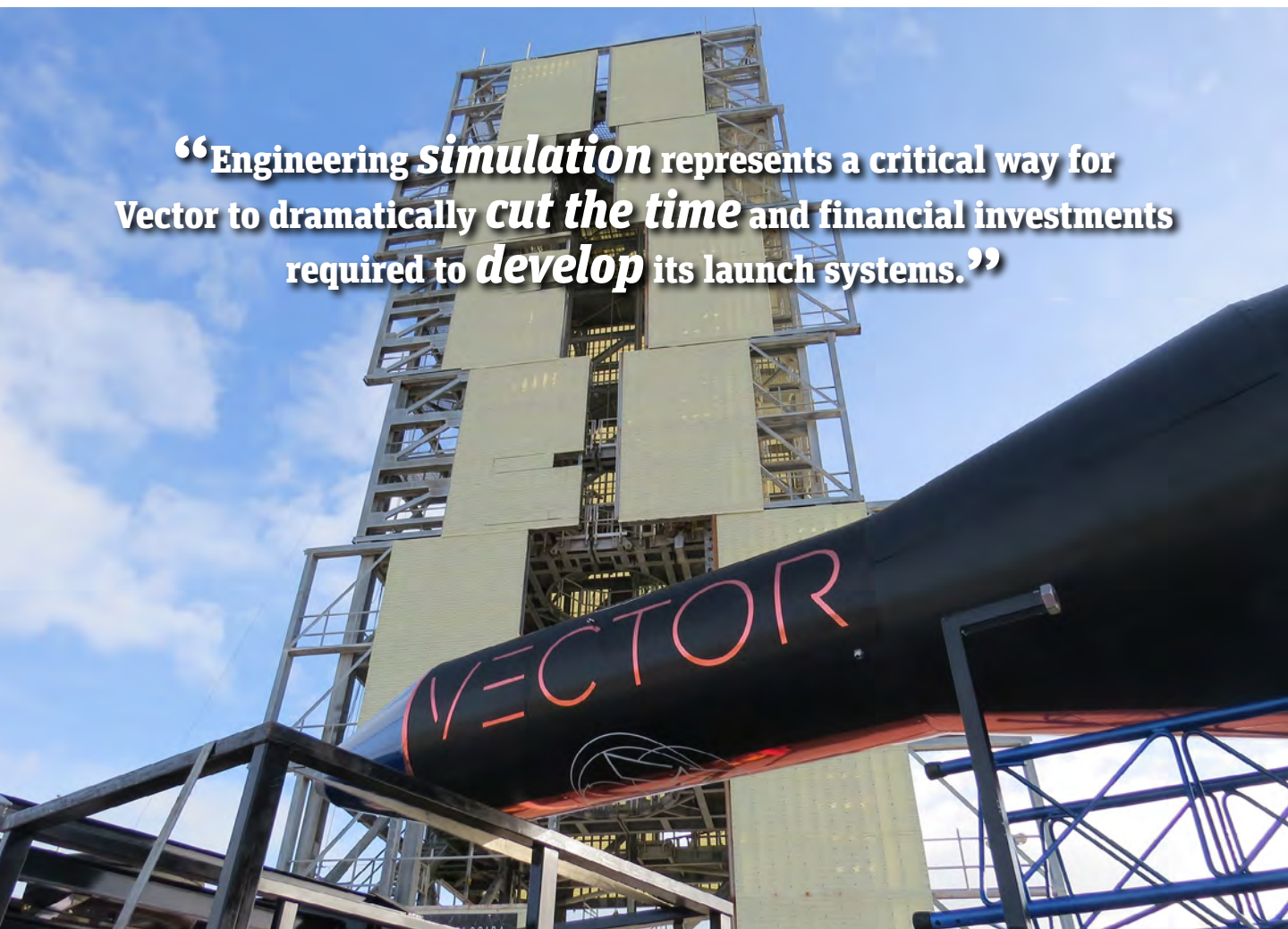

FAIL FAST, FAIL OFTEN AND FIX IT

While Vector’s product development team does try to minimize the cost of physical testing, the company also has a unique risk-taking spirit, probably because many of its executive team members have experience in Silicon Valley and the software industry.

Just as software and consumer electronics companies are not afraid to launch imperfect products — then gradually announce new releases with additional features — Vector is willing to test early product prototypes, knowing that the designs are not yet perfect. The Vector engineering team knows that these early rocket designs may not perform flawlessly, but there is much to be learned from failures — and those lessons can actually accelerate the ongoing product development effort. By combining simulation and physical testing, the Vector development team can work quickly to capture

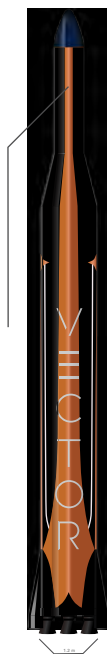

the market opportunity, while also making the best use of the limited private funds that are typical of a startup business.

Vector is currently working with the Federal Aviation Administration (FAA) for licensing orbital launches, and in the meantime the company is conducting low-altitude launches, which have a less stringent approval process. Based on these tests, the engineering team is learning about stresses during launch, failure modes, materials strength and other key design issues.

This agile engineering approach distinguishes Vector from traditional aerospace companies, which follow a “waterfall” process in which they design rockets and other systems over the course of years — then build and test prototypes only after years of design work. In addition to being time-intensive, this process consumes large amounts of capital, but it is a necessity

because large companies, working under the scrutiny of shareholders and board members, are usually risk averse. They cannot have a spectacular failure, with its accompanying media attention. Vector, on the other hand, embraces the testing that may result in a spectacular failure if it will reveal important engineering insights and inform future design iterations.



BLUE SKIES AHEAD

In its engineering and business philosophy, Vector brings together the best of both worlds: the risk-taking nature of a startup company combined with deep aerospace industry experience and technical depth. That combination should help propel Vector toward its goal of a first orbital launch in 2018.

With two low-altitude test launches on the books, Vector is making steady progress toward redefining the global satellite industry. The company's long-term goal is to schedule 100 launches annually for customers — which means engineering and building 100 rockets per year. Just as the company is applying advanced rocket and launch technologies to invent a new market category, Vector is embracing new-generation engineering practices and tools, including digital design exploration through simulation, to arrive at its ultimate destination faster. 🚀

VECTOR AT A GLANCE

Founded: 2016

Number of employees: 100

Headquarters: Tucson, Arizona



PROPELLING STARTUP SUCCESS

Today, engineering simulation software is used by the world's leading engineering teams to design and verify products quickly and cost-effectively, in a risk-free virtual space. Because the cost of licensing simulation software might be prohibitive for startup ventures like Vector, the Ansys Startup Program was created to help eligible startup companies around the globe bring their innovative product ideas to market. These entrepreneurial businesses can compete more effectively by leveraging the advanced capabilities of Ansys software, while also benefiting from the world-class engineering processes and workflows that Ansys has developed over the course of 40-plus years.

“Our ability to access Ansys software has been a key factor in establishing credibility and securing funding, as well as supporting our engineering success to date,” notes Eric Besnard of Vector. “We have very complicated problems to model, and our engineering staff consists of a relatively young team of graduate students and recent graduates. With training and support from Ansys, we are now conducting incredibly complex design explorations and engineering at the same level as much larger aerospace companies. That is helping us move forward quickly, with a very high degree of confidence in our designs.”

For more information on the Ansys Startup Program, visit ansys.com/startups.



ABOUT ERIC BESNARD

Dr. Eric Besnard is a well-known expert in aerospace system design and rocket and spacecraft propulsion, as well as launch vehicles. He has been involved in liquid propulsion research and launch vehicle technology development funded by NASA and the Air Force, including the development of innovative launch vehicle flights and technologies such as the first known aerospire and LOX/methane rocket engine flight tests. In addition to his work with Vector, Besnard is on the faculty of the Mechanical and Aerospace Engineering Department at California State University, Long Beach.

(a) Conventional Drug Delivery Method

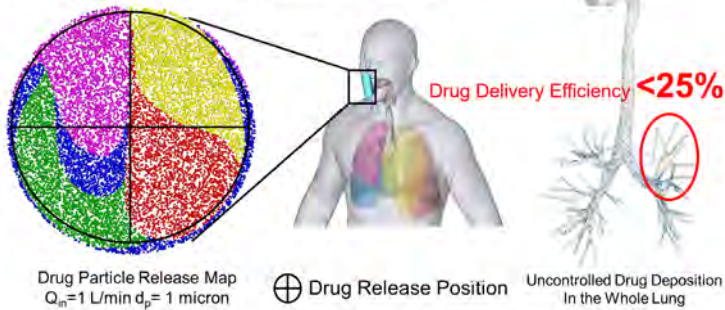

(b) “Controlled Air-Drug Stream” Targeting Method

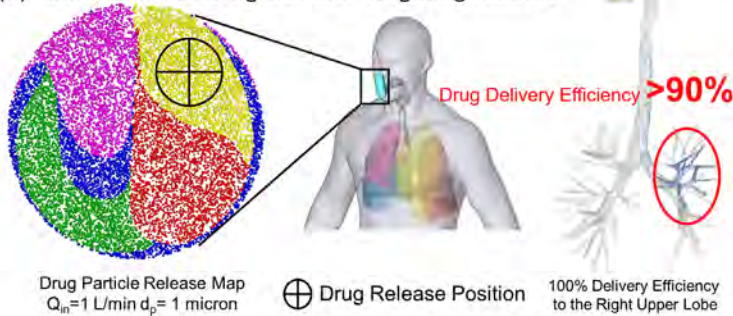

- ◀ Targeting the upper right lobe of the lung using the human digital twin prototype:
 (a) conventional drug inhalation therapy (efficiency less than 25 percent)
 (b) the controlled air-drug stream delivery method (efficiency greater than 90 percent)

Personalized medicine is starting to replace the current “one size fits all” approach to medical treatment. One goal is to deliver the right dose of the right drug, at the right time and location, to the specified patient. Researchers at Oklahoma State University used Ansys computational fluid dynamics (CFD) simulations to devise a computational fluid–particle dynamics (CFPD) method for comprehensive analysis of inhaled drug particulate matter dynamics. CFPD is designed to answer the questions: “How can we determine where a given drug

TARGETING A TUMOR

By devising a new computational method that tracks the flow of therapeutic drug particles in an aerosol from the lips to the lungs, researchers can deposit a drug on a targeted lung tumor with 90 percent efficiency. This is a major improvement over the 20 percent efficiency of conventional aerosol treatment methods. One key to the success of this new computational method is the development of a human digital twin that can be made patient-specific using the real geometry of the patient’s lungs.

By **Yu Feng**, Assistant Professor
 School of Chemical Engineering
 Oklahoma State University
 Stillwater, USA

particle in an inhaled aerosol stream ends up in the lung?” and “How can we change the properties of the aerosol to target a specific location in the lung?”

Through an academic partnership with Ansys, university researchers at the Computational Biofluidics and Biomechanics Laboratory (CBBL) apply Ansys CFD to study the precision delivery by an inhaler device of cancer-destroying drugs to tumor-only locations in the lungs (healthy tissue is not exposed). CFPD is also capable of subject-specific health risk assessment for in silico occupational exposure studies,

“By increasing the *accuracy* of delivering a chemotherapeutic drug to a lung tumor to 90 percent, versus 20 percent by conventional aerosol methods, they have *potentially improved* the prognosis for many cancer patients.”

including simulations of real-time ventilation, skin absorption and lung deposition.

COMPUTATIONAL FLUID PARTICLE DYNAMICS

In the conventional drug delivery method for inhaled aerosol medications, the drug is distributed evenly throughout the volume of the aerosol. Upon reaching the lungs, the drug reaches its target — for example, a tumor in the upper lobe of the right lung — with 20 percent accuracy. The remaining drug falls on healthy tissue. In addition to drug loss, side effects can occur and healthy lung tissue can be damaged.

To improve on this result, CBBL researchers ran CFPD simulations to provide comprehensive analysis of the flow path of particulate matter in inhaled drugs. The goal was to determine whether 100 percent of the nano-in-micro drug particles can be directed to the localized lung tumor sites by restricting the injection area of the active drug particles to a smaller region during inhalation. By varying drug particle diameters, particle density inhalation flow rate and the initial location of the drug particles in the aerosol stream, the researchers were able to simulate drug particle movement in the

aerosol through an adult upper airway configuration from the mouth to the lungs. The final mesh contained approximately 10 million dense, hybrid tetrahedral/pentahedral elements. Using Euler-Euler and Euler-Lagrange models, as well as the dense discrete phase model (DDPM) with discrete element method (DEM), the researchers confirmed that, when the drug is restricted to a smaller region of the aerosol at the point of inhalation, the delivery efficiency can reach values greater than 90 percent. This controlled-air drug stream method is clearly more efficient than the conventional aerosol delivery method.

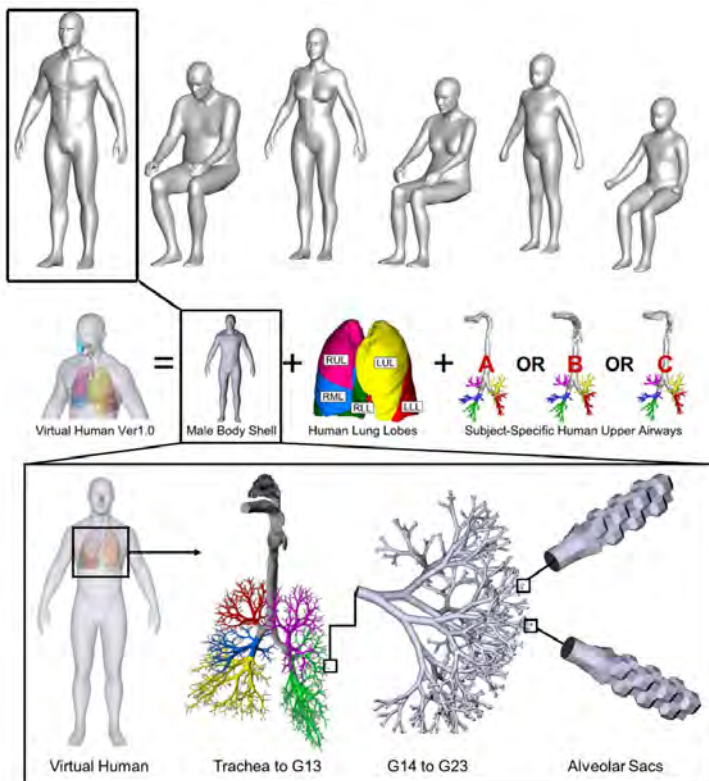

The CBBL virtual human system version 2.0 with a representative human respiratory system for computational fluid-particle dynamics (CFPD) simulations covering the entire conducting and respiratory zones

HUMAN DIGITAL TWINS

A key to the success of these simulations is the development of a “virtual human system” — an individualized digital twin. Version 2.0 of the human digital twin comprises six models: an adult male, an adult female and a child, each in sitting and standing positions. Each digital twin models a high-resolution human respiratory system covering the entire conducting and respiratory zones, lung lobes and body shell. The CBBL virtual humans are CFPD-ready. The human digital twins can be made patient-specific by performing a CT/MRI scan of the patient and importing the geometry of the lungs into the shell of the digital twin.

THE CBBL VIRTUAL POPULATION GROUP

Taking the simulations a step further, the CBBL researchers have created a large group of human

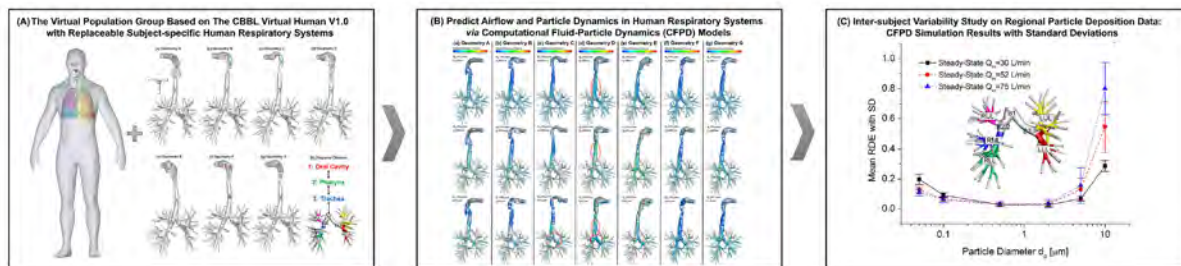

The CBBL virtual population group version 1.0 and the in silico intersubject variability investigation framework

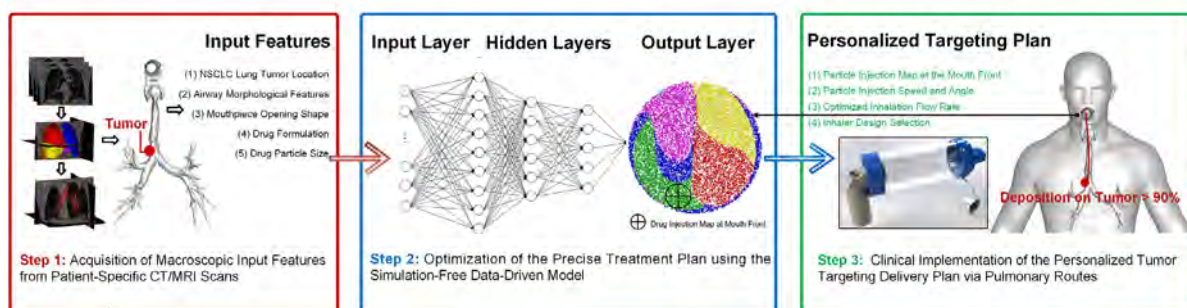

Flowchart of the personalized, targeted pulmonary drug delivery planner

digital twins for better statistical analysis — the researchers refer to this as “CFPD simulation results with error bars.” The virtual population group (VPG) is a set of detailed, high-resolution anatomical models created from CT/MRI data of human subjects. The VPG makes it newly possible to analyze variations in the general population or within specific subpopulation groups, increasing the statistical robustness of numerical studies.

However, as these analyses consider individual anatomical differences, they are computationally expensive. Using a reduced-order model (ROM) to accelerate the computation, future work will include the compilation of precomputed lung aerosol dynamics libraries to train the ROM and simplify the in silico, personalized, pulmonary drug delivery planning process.

THE MULTISCALE CFPD-PBPK/TK MODELING FRAMEWORK

The deposition of drugs in the lung is not the endpoint of the cancer treatment. Toxicologists, pharmacists and clinicians are more interested in the after-deposition dynamics, i.e., the time course of therapeutic or toxic species in plasma and different organs throughout the whole human body. CBBL has combined the CFPD model with a physiology-based pharmacokinetic/toxicokinetic (PBPK/TK) model to predict the systemic translocation of nicotine and acrolein (initial examples) in the human body after the deposition in the respiratory system. With this multiscale CFPD-PBPK/TK modeling framework, it is now possible to run simulations of extremely complex, lung-aerosol dynamics phenomena and whole-body translocation mechanisms at unprecedented levels of detail. This method can

be easily modified to fit in other pulmonary research areas, such as drug delivery and occupational exposure risk assessment.

THE FUTURE: PERSONALIZED PULMONARY HEALTHCARE PLANNER APP

CBBL researchers are now working on an app using Ansys ACT that would automate patient-specific analyses, as shown in the flowchart of personalized lung disease treatment. Clinicians could use the app to design a treatment plan. With a few morphological parameters based on the patient-specific CT/MRI data of the human respiratory system, as well as the coordinates of known lesions, the personalized pulmonary healthcare planner could provide an integrated solution to target localized lung sites based on a pre-computed database connected with a reliable machine-learning model. This fast, noninvasive, reliable, easy-to-use app is also patient-specific, and would prescribe treatment based on a personal digital twin.

“The human *digital twin* can be made patient-specific by performing a CT/MRI scan of the patient and importing the geometry of the lungs into the shell of the *digital twin*.”

Researchers at the Computational Biofluidics and Biomechanics Laboratory at Oklahoma State University used Ansys CFD to develop a unique simulation method that will advance the field of personalized medicine. By increasing the accuracy of delivering a chemotherapeutic drug to a lung tumor to 90 percent, versus 20 percent by conventional aerosol methods, they have potentially improved the prognosis for many cancer patients. The advancement of patient-specific, or personalized, medicine will continue to be dependent on the work of innovative researchers and the development of new simulation techniques to eradicate disease. 📍

ACKNOWLEDGMENTS

The use of Ansys software as part of the Ansys-OSU academic partnership agreement is gratefully acknowledged. Some of the computing for this project was performed at the OSU High Performance Computing Center at Oklahoma State University (Dr. Dana Brunson, Director, and Dr. Evan Linde, Research Cyberinfrastructure Analyst).

References

[1] Feng, Y. A New Patient-Specific Pulmonary Drug Targeted Delivery Method to Treat Lung Cancer using E-Cigarette Technology. *Proceedings of the AIChE 2017 Annual Meeting, Minneapolis, MN, USA, Oct.–Nov., 2017.*

[2] Feng, Y.; Chen, X.; Xu, Z.; Haghnegahdar, A. Intersubject Variability in Pulmonary Drug Delivery Efficiency to Target Lung Tumors at Different Lobes: An In-Silico Study. *Proceedings of the BMES 2017 Annual Meeting, Phoenix, AZ, USA, 2017.*

[3] Feng, Y.; Xu, Z.; Haghnegahdar, A. Computational Fluid-Particle Dynamics Modeling for Unconventional Inhaled Aerosols in Human Respiratory Systems. *Aerosols – Science and Case Studies, 2016,* DOI: 10.5772/65361.

[4] Haghnegahdar, A.; Feng, Y.; Chen X.; Lin, J. Computational Analysis of the Deposition and Translocation of Inhaled Nicotine and Acrolein in Human Body with E-cigarette Puffing Topographies. *Aerosol Science and Technology,* In Press, **2017.**

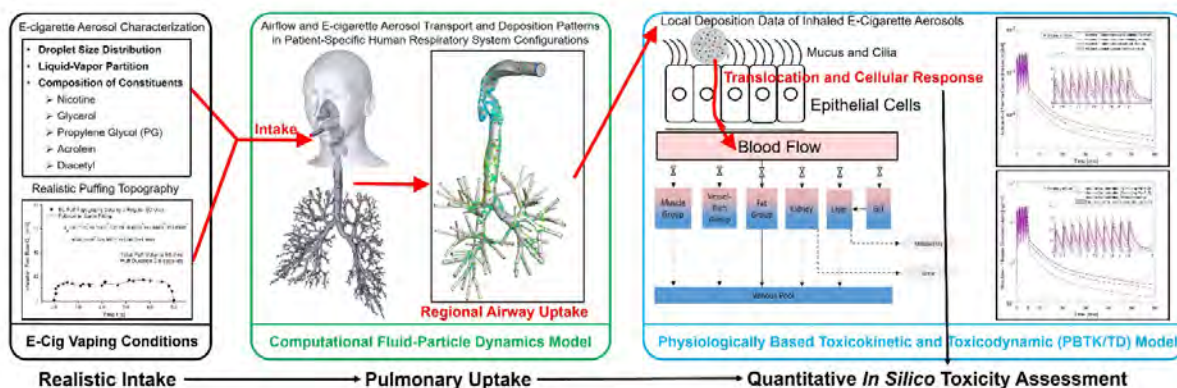

The multiscale computational fluid-particle dynamics (CFPD) plus physiological-based toxicokinetic (PBTk) modeling framework

ABOUT DR. YU FENG

Dr. Yu Feng is an assistant professor in the School of Chemical Engineering at Oklahoma State University, and a center investigator in the Oklahoma Center for Respiratory and Infectious Diseases (OCRID). He founded the Computational Biofluidics and Biomechanics Laboratory (CBBL) at Oklahoma State University, which focuses on developing and applying advanced CFPD models toward multiple applications associated with pulmonary healthcare. He has over 10 years of experience in modeling lung-aerosol dynamics on Ansys CFX and Fluent platforms, and is published in more than 20 top-ranked journals of fluid dynamics and aerosol science.



Cool Idea for Engine Design

Achates Power has developed a radically improved two-stroke opposed-piston internal combustion engine that increases fuel efficiency and reduces greenhouse gas emissions. Ansys simulation tools help the company to shorten design iteration time, minimize hardware prototypes and reduce the development time of new engines by approximately one year.

By **Dnyanesh Sapkal**, Vice President, Mechanical Systems Engineering
Achates Power, Inc., San Diego, USA

The new engine from Achates Power, Inc., is approximately 50 percent more fuel-efficient than conventional gasoline engines and 30 percent more fuel-efficient than diesel engines in combined city and highway drive cycles. This improvement was accomplished by eliminating the cylinder head in an opposed-piston configuration, which reduces the surface area of the combustion chamber relative to its volume, and therefore decreases heat transfer and heat rejection, the waste heat transferred to the coolant and metal. When less heat is wasted through the cooling systems, more fuel energy is available for useful work. Decreasing heat transfer to the coolant also makes it possible to shrink the cooling system and radiator size, reducing the overall system weight and cost.

Because the engine has no cylinder head, the piston and cylinder liner must absorb a larger proportion of the heat generated by combustion, which is quite an engineering challenge. Achates Power engineers address this and other design challenges with Ansys simulation tools for computational fluid dynamics (CFD), conjugate heat transfer (CHT) and structural/thermal simulation to identify failure modes early in the design phase and fix potential issues well in advance of building and testing physical prototypes.

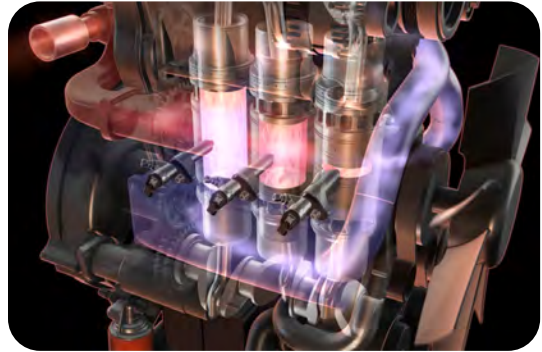

“Intensive use of *Ansys simulation* tools has enabled *Achates Power* to rapidly eliminate failure modes by iterating designs in days as opposed to months.”

A Common Platform Shortens Development Time

Ansys simulation tools provide Achates Power engineers with a common platform that has many options for solving multiphysics problems and exploring alternative designs. The design process starts with identifying all failure modes of concern. Engineers develop a computer-aided engineering (CAE) model so they can modify and evaluate designs virtually to shorten development time. Many analysis procedures used at Achates Power are automated with Ansys Workbench templates, reducing the time

required for model setup and ensuring the use of consistent procedures and assumptions.

Engineers perform real-time measurement of engine operating parameters such as temperature, pressure and flow at various conditions, and feed the data back into the

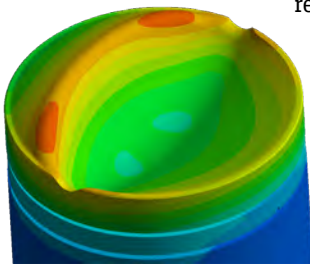

Hot spots predicted by advanced thermal modeling on the crown of the piston are addressed by changing the combustion parameters and bowl shape.

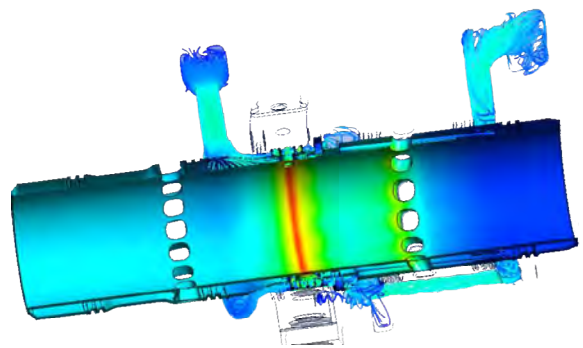

Conjugate heat transfer simulation results for the cylinder show high temperatures at the injector plane in the center of the cylinder axis.

analysis models to anchor them to real-life conditions. The team evaluates the simulation results and test data to locate the “cliff” — the point at which failure occurs. By iterating the design in the simulation environment, engineers can understand how design parameters affect key failure modes and move the design as far as possible from the cliff. Wherever possible they confirm the robustness of the design with accelerated lifetime testing.

Cylinder Liner Thermal-Mechanical Simulation

To manage the heat in the cylinder liner, Achatas Power engineers first employ Ansys CFD to simulate the cooling channels so they can optimize flow rates, flow distribution and fluid velocity. They perform a 3D gas-side Ansys CFD simulation to determine wall heat transfer coefficients (HTCs) at a particular bulk temperature. Then another CFD simulation is done to calculate wall HTCs due to other heat sources, such as land gap heat. Similarly, ring-friction and piston-skirt-friction heat flux numbers calculated using a different tool are converted to equivalent HTCs. The cycle-averaged wall HTCs obtained from the gas-side CFD simulation and friction model are then used in the fluid-solid CHT simulation model to calculate metal temperatures. These metal temperatures and gas pressure conditions are applied to an Ansys Mechanical thermal-structural

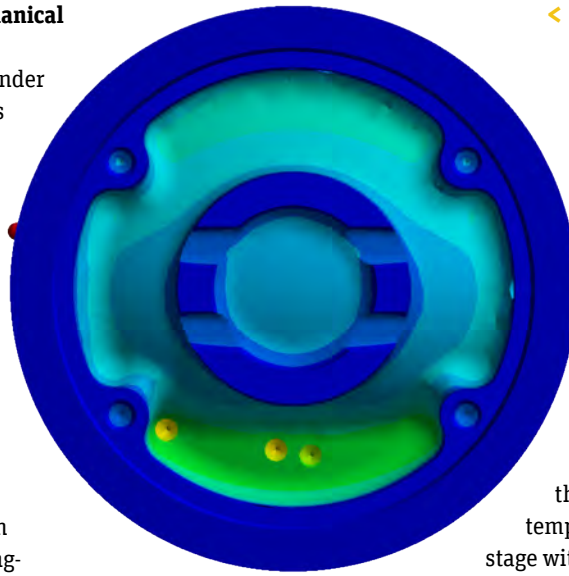

◀ Temperatures under the crown of the piston as predicted by advanced piston thermal modeling

time providing sufficient cooling to make pistons durable. Excessively high temperatures on the piston crown and under the crown can lead to several different failure modes, including crown oxidation, piston cracking and oil coking. To that end, predicting piston temperatures early in the design stage without actual test data is very important. Achatas Power engineers perform transient simulation of open and closed cycles using a special combustion code to determine spatially resolved time-average heat flux distribution on the piston crown. The heat flux numbers from the combustion model are then mapped into an Ansys Mechanical steady-state thermal model that predicts the piston crown temperatures. In the advanced piston

“Design is an iterative and *evolutionary process* that requires *finding a balance* among many factors.”

FEA model that calculates stresses and distortion in the cylinder liner. The stress numbers from the Ansys Mechanical model are then fed into the fatigue code to estimate the fatigue life of a liner. Achatas Power has significantly improved the thermal model fidelity of the liner by identifying all possible heat sources and correlating the CHT model to the measured data. This simulation process has enabled Achatas Power engineers to predict realistic temperatures on the liner surface and iterate the design to eliminate liner failure modes, such as ring/bore scuff, liner cracking and excessive bore distortion.

Piston Thermal-Mechanical Simulation

In opposed-piston engines, management of heat transfer into and out of the piston is critically important to keep pistons hot enough to maximize the brake thermal efficiency (BTE) but at the same

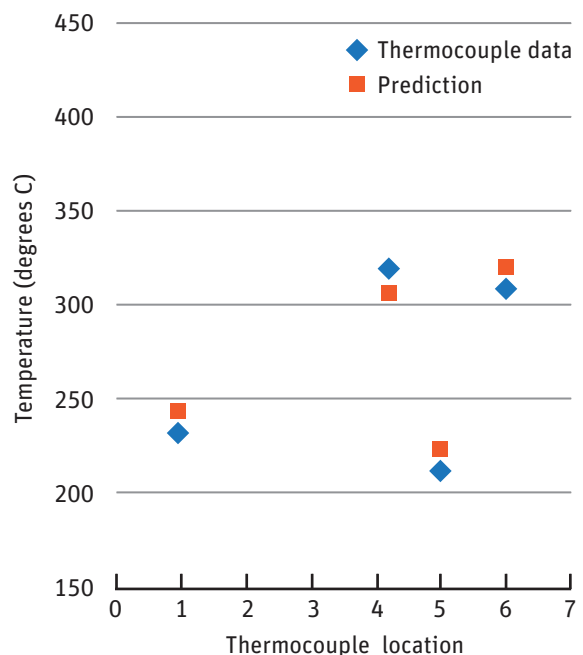

Piston temperatures as predicted by advanced thermal modeling correlate well with thermocouple measurements.



“The new engine from Achates Power, Inc., is approximately 50 percent more fuel-efficient than conventional gasoline engines.”

thermal modeling process, Achates Power engineers also run an undercrown oil flow CFD simulation to determine the gallery fill ratio and estimate HTC. The entire simulation process between combustion CFD and Ansys thermal modeling is iterated several times until the desired metal temperature convergence is achieved. The flexibility of Ansys Workbench simplifies the process of integrating third-party tools into the analysis workflow. The piston metal temperatures obtained from the iterative thermal simulation are then mapped into an Ansys Mechanical thermal-structural model to calculate stress and deformation due to thermal and gas pressure loads. The stress data from the thermal-structural model is then fed into the fatigue code to calculate the piston fatigue life.

Using simulation to predict piston temperatures of individual design points and iterating the design to improve the temperature distribution, Achates Power engineers address piston failure modes in the early stages of the design process. As a result, they have significantly reduced the power cylinder development

time by decreasing hardware iterations and also significantly improved durability of their engines in the past four years.

Design is an iterative and evolutionary process that requires finding a balance among many factors such as functional specifications, efficiency, durability, noise-vibration-harshness, mass and cost. Achates Power engineers continuously improve the modeling process by stretching the limits of the analysis tools to explore uncharted territories and capture real-world operating conditions. Intensive use of Ansys simulation tools has enabled Achates Power to rapidly eliminate failure modes by iterating designs in days as opposed to the months that would be required if they were using a traditional design process primarily based on physical prototypes. As a result, Achates Power now completely designs and develops new engines in one and a half years compared to three years with the traditional process. 

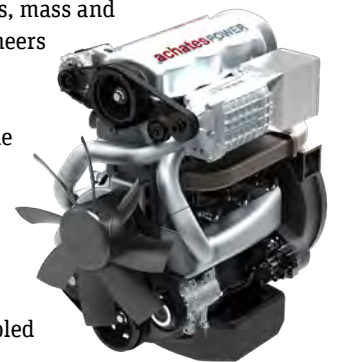



A Closer Look at

Optical Simulation

With its acquisition of OPTIS, Ansys has expanded its industry-leading software portfolio to include the engineering simulation of light, human vision and physics-based visualization.

By **Eric Bantegnie**
Vice President and
General Manager – Systems
Ansys

For more than 30 years, optical simulation has proven to be critical for manufacturers of lighting products, including lasers, scanners, lenses and lighted displays. By simulating how these products will perform under a variety of real-world lighting situations, product developers can optimize actual performance – for example, ensuring that a dashboard display or a taillight is visible at night – without investing in expensive physical prototypes.

Over the last decade, the demand for accurate optical simulation has grown exponentially, leading to significant advances in software capabilities in this area. With the advent of virtual reality and autonomous vehicles, the engineering spotlight has never shone brighter on optical sensors, displays and related technologies.

To meet its customers' growing need to incorporate optical sensing and lighting components in their products, Ansys recently acquired OPTIS, a premier provider of software for the scientific simulation of light, human vision and physics-based visualization. Accurate optical simulation is of special importance to the automotive industry, but the company's customer list also includes world leaders in aerospace, cosmetics and many other industries.

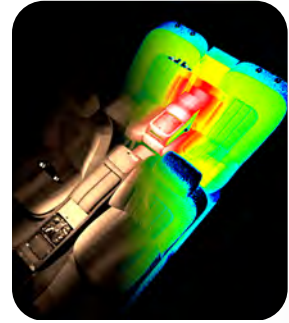

Autonomous Vehicles: Putting Optics in the Spotlight

As the global automotive and aerospace industries race to develop safe autonomous vehicles, accurate sensor development is critical. Optical sensors replace the human eye, enabling the vehicle to distinguish important objects like lane markings and dividers, other vehicles, pedestrians and signs. This process is incredibly complex. Not only must driverless cars “see” a traffic signal, they must identify its color accurately, at any time of day or night, under a variety of weather conditions. Sensors need to distinguish between dense fog or precipitation and real physical objects. They are mission-critical, as human safety depends on their accurate, reliable performance.

Ansys has already created simulation solutions specifically for autonomous vehicle (AV) development, and now offers a comprehensive AV simulation solution. Ansys simulation capabilities now cover visible and infrared light, electromagnetics and acoustics on the physics side — as well as ISO 26262 certified embedded software controls, graphics development tools and systems safety analysis tools.

“By tightly integrating OPTIS solutions into its industry-leading multiphysics simulation portfolio, Ansys is accelerating the development and delivery of innovative products to the marketplace.”

PRODUCT SPOTLIGHT: VRX

VRX is a unique optical simulation solution that supports an exploration of the driving environment, exactly how a real driver would see it. By replicating a real-world physical environment in 3D and creating a real-time, virtual-reality-based driving experience, VRX allows product developers to experience an autonomous vehicle under many daytime and nighttime driving scenarios, taking into account road and weather conditions. Extensive content libraries enable the creation of unlimited scenarios. Engineers can be confident that the vehicle is accurately “seeing” traffic, pedestrians, road signs and markings — as well as observing safe driving regulations and standards.





These best-in-class simulation capabilities enable product developers to design the underlying technology for camera-, radar- and lidar-based sensing systems. They can perform closed-loop simulations that integrate embedded software intelligence with the 3D physical environment their autonomous vehicles will navigate, including road conditions, weather and one-way streets.

A Spectrum of Customer Applications

Beyond manufacturers of autonomous vehicles, new optical simulation capabilities from Ansys have wide-ranging applications for many customer businesses.

Optical simulation helps designers perfect the physical appearance of every product and package under virtually any possible lighting condition.

“By providing the most accurate and comprehensive multidisciplinary and *cross-functional simulation* technology on the market, Ansys – along with OPTIS technology – will help bring safe, reliable *autonomous vehicles* to market sooner.”

Optical simulation also supports the development of ultraviolet solutions for water purification, bacteria decontamination and electronic wafer insolation – as well as the development of infrared solutions for defense and satellite applications.

Effective simulation of lighting conditions and solar energy levels is also essential for architects, artificial lighting designers, engineers of solar

PRODUCT SPOTLIGHT: SPEOS

SPEOS enables product developers to predict how light will affect their designs, without the need for a physical prototype. By supporting the creation of a virtual mock-up, SPEOS equips designers with the ability to “see” how their product will look and perform under various lighting conditions. This powerful solution supports the development of advanced lighting technologies – such as backlit displays, sensors, augmented reality glasses, fingerprint recognition systems and biomedical equipment – and also car paints and interiors, aircraft cockpits and passenger cabins. SPEOS simulates human vision within a virtual illuminated environment, providing ultrarealistic visualization of what the human eye will see. Companies can benefit from this solution’s ability to generate an exact visual representation of products as customers will actually perceive them – resulting in an accelerated decision-making process and designs that are optimized for light.





panels and solar farms, healthcare product developers focused on skin cancer detection, and other market needs.

For manufacturers, new visualization tools from Ansys help predict manufacturing variations and their impact on perceived product quality. By identifying potential variations at the earliest possible design stage, engineers can ensure that products are produced to the highest possible quality standards, the first time and every time.



An Expanded Vision

For more than 40 years, Ansys has built a tradition of supporting product excellence and innovation by simulating multiple physical forces, including mechanical and

fluid stresses, temperature variations and electromagnetics — as well as by supporting embedded software controls development, systems safety analysis and holistic systems simulation.

With light emerging as a critical product consideration for today's autonomous, smart and connected products, it only makes sense for Ansys to offer the world's leading software for optical simulation. By tightly integrating OPTIS solutions into its industry-leading multiphysics simulation portfolio, Ansys is accelerating the development and delivery of innovative products to the marketplace, while lowering design costs and enhancing the safety of many diverse product systems. 🚀



Simulation in the News

ANSYS 19.1 — NEXT-GENERATION PERVASIVE ENGINEERING SIMULATION

Design Products and Applications, May 2018

The latest release of Ansys software builds upon its industry-leading products and platform across all physics, empowering customers to accelerate productivity and eliminate product complexity — lowering costs and time to market. It includes advances in the simulation of structures, fluids, electromagnetics, semiconductors, systems and certified software that improve reliability, performance, speed and user experience. This release features some exciting new products.



19.1
RELEASE

ANSYS TWIN BUILDER



This first-of-its-kind product enables companies to build, validate and deploy simulation-based digital twins

within one workflow — potentially saving millions of dollars for customers in the oil and gas, industrial, energy, and aerospace and defense industries.

ANSYS ADDITIVE SUITE

New metal additive manufacturing solutions empower customers to quickly test their product designs virtually before printing a part. The Ansys Additive Suite enables designers to optimize weight reduction and lattice density; create, repair and clean up CAD geometry; simulate the additive process; and conduct structural and thermal analysis for data validation.

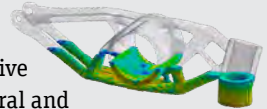

 19.1 Release
ansys.com/19

GENERAL ELECTRIC CO. ENTERS INTO MULTIYEAR AGREEMENT WITH ANSYS

Pittsburgh Business Times, February 2018

The agreement provides GE access to the full breadth of Ansys's industry-leading portfolio of engineering simulation software and experts, to enable multiphysics solutions in ground-based and on-wing gas turbine engines.

“With Ansys technology further integrated into GE’s engineering process, we can take our 30-year collaboration to the next level of strategic partnership, and enable Ansys and GE to better drive innovation.”

— Ajei Gopal, CEO, Ansys



TSMC CERTIFIES ANSYS SOLUTIONS FOR ADVANCED 5NM PROCESS

HPCwire, April 2018

Ansys RedHawk and Ansys Totem have been certified by TSMC for the latest 5nm FinFET process so that mutual customers can meet increasing demands for next-generation mobile and high-performance computing (HPC) applications.



ROLLS-ROYCE, THE UNIVERSITY OF NOTTINGHAM AND ANSYS PARTNER TO TRANSFORM AERO ENGINES

NAFEMS, March 2018

Collaborating in a research project, the three partners will improve modeling and simulation for bearing chambers and internal flow using new techniques to address air and oil flows in the engines. This will assist in the development of next-generation clean and quiet aero engines.

EMBRAER AND Ansys ACCELERATE TIME TO MARKET FOR NEXT-GENERATION AIRCRAFT

MCADCafé, April 2018

Embraer’s latest commercial jet made history as the only aircraft to receive on-time certification simultaneously by the Federal Aviation Administration, European Aviation Safety Agency and Brazilian Civil Aviation Agency. With Ansys software onboard, Embraer met complex targets for flight performance in record time – confidently bringing cutting-edge aircraft to market faster than ever.



Ansys ACQUIRES OPTIS

engineering.com, May 2018

With the acquisition of optical simulation leader OPTIS, Ansys now delivers the industry’s most comprehensive solution for simulating autonomous vehicles. By adding OPTIS’s optical sensor and closed-loop, real-time simulation to Ansys’s leading multiphysics portfolio,

the company offers the broadest toolset for validating the safety and reliability of autonomous vehicles – speeding time to market for these vehicles by mitigating the need for billions of miles of road testing.



ENVISIONING THE SENSEABLE CITY AND THE IOT

Connected World, February 2018

The ways that industries operate and that people live, work and play are all enabled by sensors. Sensors are vital to reducing waste, decreasing human error and improving throughput.

“The world will become a small village. Your location will not matter as long as you are part of the network.”

– Laila Salman, Ansys

A NEW PROBLEM FOR HIGH-PERFORMANCE MOBILE

SemiWiki.com, April 2018

Leading mobile vendor/suppliers are challenged by a new problem. They were hitting target 2.5 GHz performance goals on their application processors, but the yield was about 10 percent lower than expected. Using Ansys semiconductor tools they were able to pin down the source of the problem.

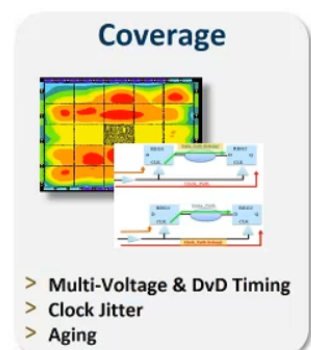
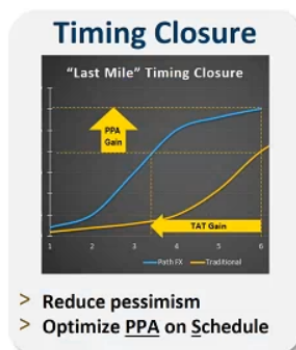
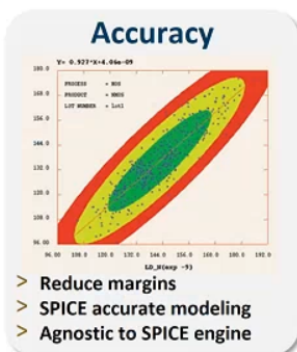

Ansys and SAP Partner to Unveil Insights from Rich Data Across Engineering and Operations Value Chains

MCADCafé, June 2018

Ansys and SAP SE have entered into a partnership to enhance the Intelligent Enterprise by linking engineering and operations with the digital supply chain and asset management. The first product of this partnership — called SAP Predictive Engineering Insights enabled by Ansys — will create value by optimizing operations and maintenance based on real-time engineering insights. It will run on an SAP Cloud Platform to maximize speed, availability and flexibility.

The solution embeds Ansys's pervasive simulation solutions for digital twins — Ansys Twin Builder — into SAP's market-leading digital supply chain, manufacturing and asset management portfolio. SAP Predictive Engineering Insights enabled by Ansys will reduce product cycle times and increase profitability by substituting predictive and prescriptive maintenance for traditional time-based maintenance of industrial assets. The combination of Ansys and SAP solutions

yields a unique software product that combines engineering and business insights in one package.

Organizations will reap tremendous benefits by using digital twins — virtual copies of a physical assets — to harness the massive amounts of data created during simulation and from data gathered by sensors on assets. By linking those diverse data sets, engineers gain valuable insights into product behavior to improve future development and spur innovation. Additionally, they can develop hybrid models that fuse machine learning with deep physics simulation models to accurately predict how an asset can fail after it is deployed. By tracking how assets are designed, built and operated throughout the product lifecycle, organizations can gain immediate and valuable insights using SAP Predictive Engineering Insights enabled by Ansys. This cloud-based industrial Internet of Things (IoT) solution uses a combination of real-time and predictive engineering

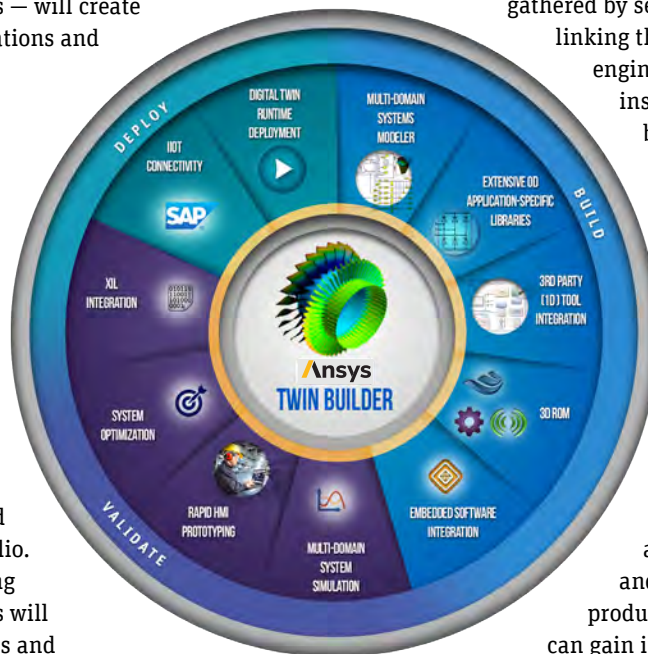

“A digital twin that ties together engineering models, manufacturing details and operational insights including financial information is unique in the industry.”

— Hala Zeine, president, Digital Supply Chain and Manufacturing, SAP



analyses through Ansys Twin Builder to build, validate and deploy digital twins. To connect a digital twin to test data or real-time data, Twin Builder easily

integrates with IoT platforms like SAP's cloud-based solution and provides runtime deployment. Once connected, the digital twin uses the current state of a product (including behavior under various environments and stresses) to simulate future states, enabling prediction of when problems might occur.

This unique solution combines data, simulation and financial information to improve operation and maintenance of equipment and systems in a wide variety of industries.



Groundbreaking Integrated Solution for Design at the Speed of Thought

Robotics & Automation News, June 2018

Ansys and PTC have partnered to deliver Ansys Discovery Live real-time simulation within PTC's Creo® 3D CAD software. The combined solution will be sold by PTC as part of the Creo product suite. This solution offers customers a unified modeling and simulation environment, removing the boundaries between CAD and simulation, and enabling design engineers to gain insight into each of the many design decisions they make throughout the product development process. Design engineers will be empowered to create higher-quality products, while reducing product and development costs.

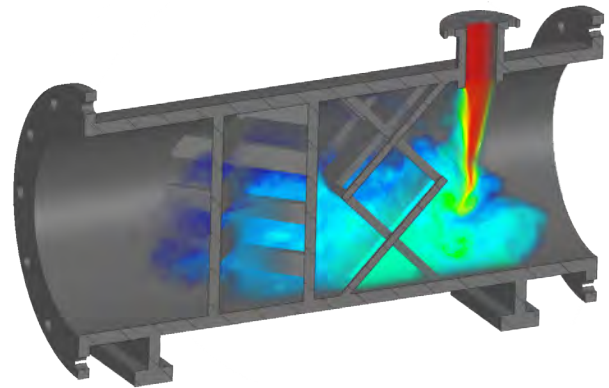

The collaboration between Ansys, the leader in engineering simulation, and PTC, the leader in 3D CAD, leverages the companies' respective technology strengths and market presence. Ansys developed its

“This capability has the potential to dramatically improve engineering productivity and quality, and the combined solution can be a differentiator in the market.”

— Jim Heppelman, president and CEO, PTC

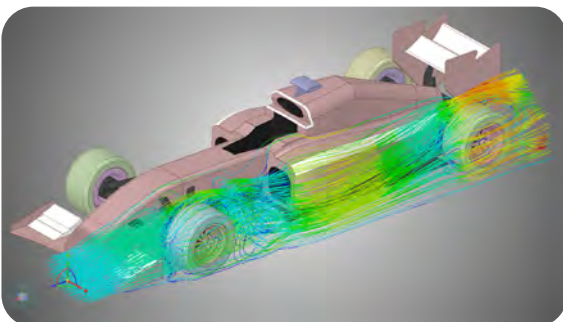

groundbreaking, real-time simulation solution, Ansys Discovery Live, to further its strategy of pervasive engineering simulation. This combined solution will give designers the power of Creo, the award-winning 3D CAD solution from PTC, fully integrated with Ansys Discovery Live. The integration of these two leading solutions brings real-time simulation into the modeling environment, creating an interactive design experience.



ANSYS, Inc.
Southpointe
2600 Ansys Drive
Canonsburg, PA U.S.A. 15317

Send address corrections to
AdvantageAddressChange@ansys.com

PERVASIVE ENGINEERING SIMULATION MEANS ROAD WORRIER NO MORE



You've got a lot riding on — and in — your autonomous vehicle. Safety is paramount and speed to market is critical. Only Ansys can deliver a complete simulation solution for designing, testing and validating your autonomous vehicle.

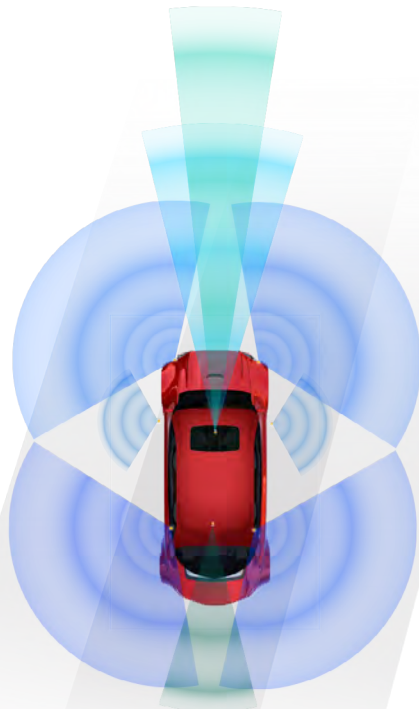

Learn more at [ansys.com/autonomous](https://www.ansys.com/autonomous)

