

ANSYS AIM HIGH SCHOOL PROJECT GUIDE

OFFICE CHAIR DESIGN

SCHOOL

Peters Township High School (McMurray, Pennsylvania)

INSTRUCTOR

Christopher Allen

CONTACT

allenc@pt-sd.org

PROJECT OBJECTIVE

Design an office chair based on predefined parameters

PROJECT OVERVIEW

This project follows the iterative design method (prototyping, testing, analyzing, and refining the design) to achieve minimum requirements with a primary goal of a project-based approach to structural design. It is completed in a digital format using ANSYS AIM to test designs, but can be adapted to include a traditional manufacturing component. Minimum project requirements are taken from the Americans With Disabilities Act (ADA) and modern manufacturing standards.

PROJECT STRATEGY

This project relies upon the scaffolding method in education culminating with a project-based challenge. Prior knowledge includes parametric modeling techniques, structural engineering concepts, product development concepts, product design techniques, manufacturing standards, and material science. As the final project for the course, students are presented with this project in three overall phases: research, design and testing, and final presentation.

Research Phase: As an introduction to this project, students begin with a experiential research assignment that requires they develop and utilize an evaluation system for current chairs on the market. Then they meet and interview other people who work in office environments to understand what they expect and would like in a new type of office chair.

Design and Testing Phase: Students begin preliminary designs in the form of rough sketches and moving on to technical drawings. This leads them into the parametric modeling phase of the project and then into structural analysis of their designs using ANSYS AIM. Finally, students evaluate the data from the structural analysis and use it to iterate on their design. With each new iteration, at least five required, of their design they test the structural performance under the given loads to reach a final design.

Final Presentation Phase: This phase requires a presentation which outlines their process in each of the three overall phases, as well as a visual demonstration of their iterative design process.

EARTHQUAKE RESISTANT BUILDING REQUIREMENTS AND GRADING RUBRIC

DIRECTIONS

Design a new type of office desk chair based on the **Design Requirements** and **Grading Rubric** listed below. The structural integrity of the chair will be tested using ANSYS AIM simulation software. The parameters of the simulation and how you will be graded is listed below.

DESIGN REQUIREMENTS		
Seat	Backrest	Armrests
Legs: 3-5 individual	Legs: Only part touching ground	
<p>Aesthetic Design: Aesthetics is a study of the mind and how our brains interpret something as being beautiful or ugly. It is crucial for design because our first interaction with almost anything is based on how it looks.</p>		
<p>Ergonomic Design: Ergonomics is the science of refining the design of products to optimize them for human use. Human characteristics, such as height, weight, and proportions are considered, as well as information about human hearing, sight, temperature preferences, and so on. Ergonomics is sometimes known as human factors engineering.</p>		

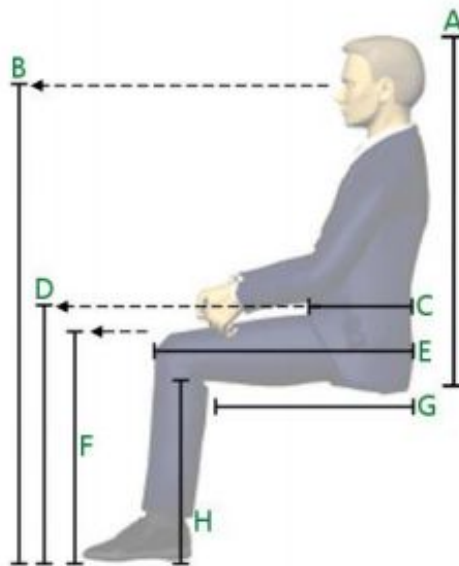

Dimensional Requirements []

DIMENSIONAL REQUIREMENTS	
Max Material Thickness	3"
Range of Overall Width of Seat (Not Overall Chair Dimensions)	13.9" – 18.0"
Range of Backrest from Seat Height (A)	31.3" - 38.3"
Range of Waist Depth (C)	7.3" – 11.4"
Range of Thigh Clearance (D)	21.0" – 26.8"
Range of Back-to-Knee (E)	21.3 – 26.3"
Range of Seat Depth (G)	16.9" – 21.1"
Knee Height (F)	19.8" – 28.0"
Range of Seat Height from Ground (H)	19.8" - 25.0"
Distance Between Armrests	16.5" – 19.0"
Max Height	80"
Max Width	32"

GRADING RUBRIC

Structural Efficiency (10 pts.)			
Mass of Chair			
Weight Requirements: Test the structural integrity of your chair design using the following weights, converting them to Pascals first.			
	$F = \frac{W}{A}$		
Pounds	275	300	450 (Bonus)
Newtons			
Structural Efficiency Score: Use the structural efficiency equation to determine your structural efficiency score. In the box below calculate your structural efficiency score based on your results and show your work. The Mass Held amount should be the weight held by your chair with no yellow areas during the Equivalent Stress simulation .			
$T = \frac{F}{A}$			

Simulation Results (60 pts.)					
Equivalent Stress (40 pts.): If the maximum value of equivalent stress induced in the material is more than strength of the material the design will fail. Points are awarded based on the performance of your design in the simulation.					
Weight	275		300		450 (Bonus)
Stress	Below Yellow	Yellow	Below Yellow	Yellow	Below Yellow
Value	30	20-29	40	31-39	50
Displacement Magnitude (20 pts.): Distance, as measured directly between the start point and the end point with no directional consideration.					
Below Yellow		Yellow (based on the number of contact points)			Above Yellow
5		6-19			20

Design Evaluation		
Design Requirements Adherence: Minus 10 pts. from final grade for every missing part		
Seat	Backrest	Armrest
Legs: 3-5 individual	Legs: Only part touching ground	
Dimensional Requirements: Minus 5 pts. From final grade for every infraction		
Aesthetic Design: Minus up to 5 pts. from final grade based on quality of aesthetic		
Ergonomics: Minus up to 5 pts. from final grade based on quality ergonomic design		

EARTHQUAKE RESISTANT BUILDING SIMULATION PROCESS GUIDE

1. ANSYS AIM and File Setup

a. When AIM opens you will see the following screen

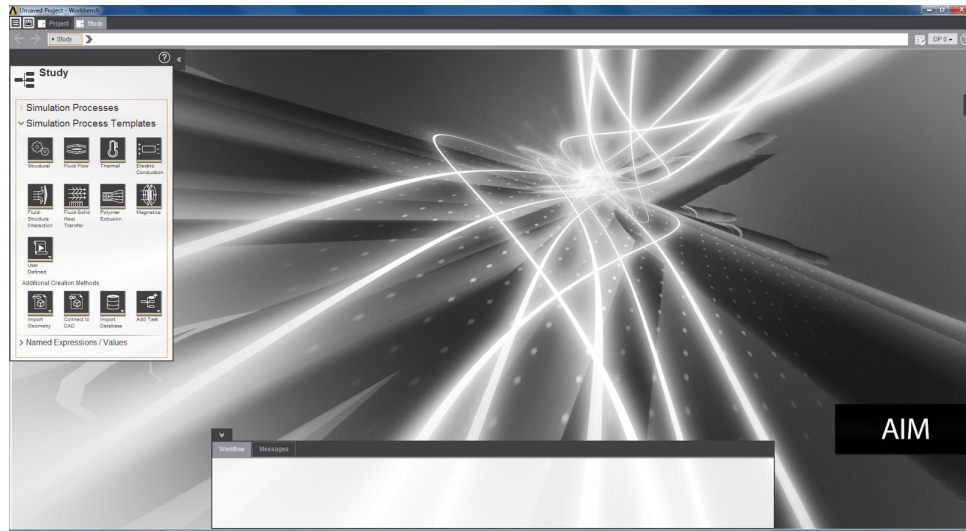

b. In the **Study Panel** select **Structural** for the Simulation Process Template

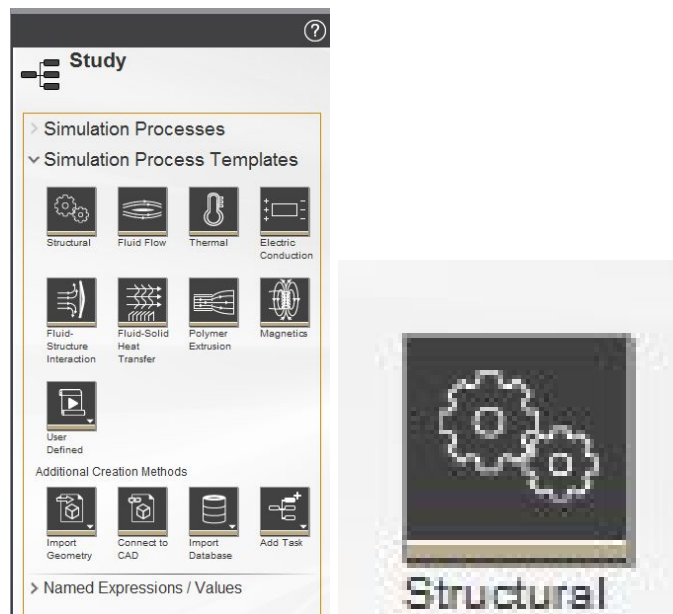

- c. On the next menu, **Structural Template**, everything for the project file should be set and look like the following image.

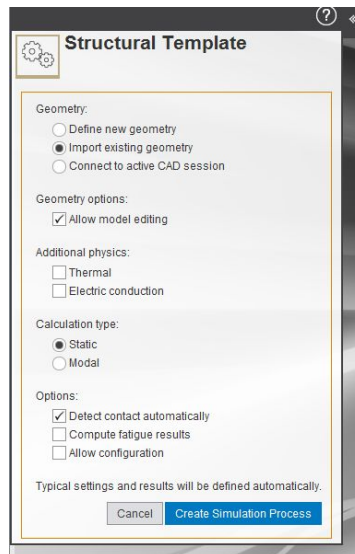

- d. Click **Create Simulation Process** and a panel will open to **Import Existing Geometry**, which is where you will select your **STEP File (.STP)**

2. Prepare and Edit Geometry

- a. Once your geometry has imported you will be looking at a new window with 3 important areas we will be using to set up our simulation

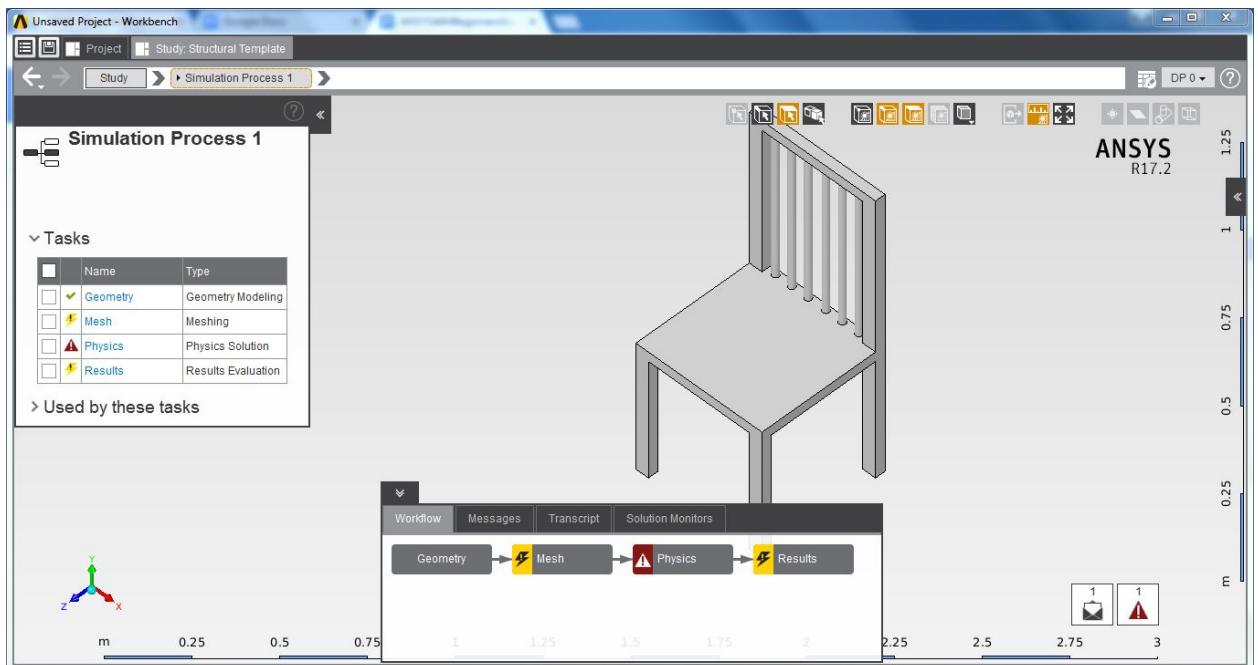

i. Area 1 - Geometry View

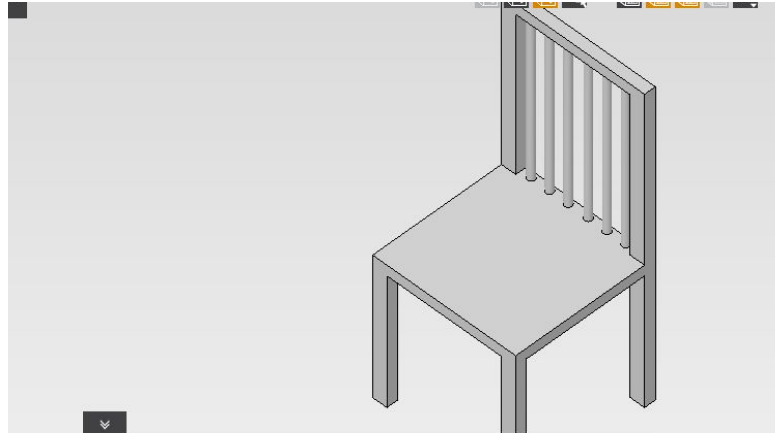

ii. Area 2 - Workflow

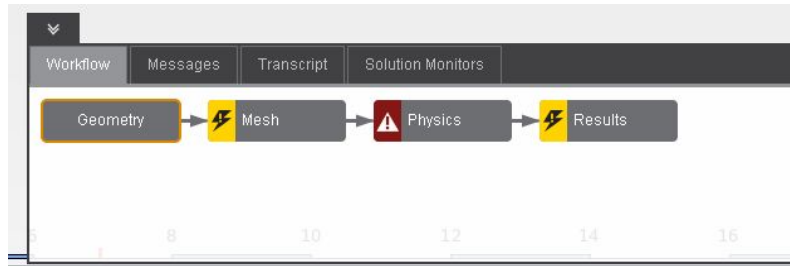

iii. Area 3 - Simulation Process

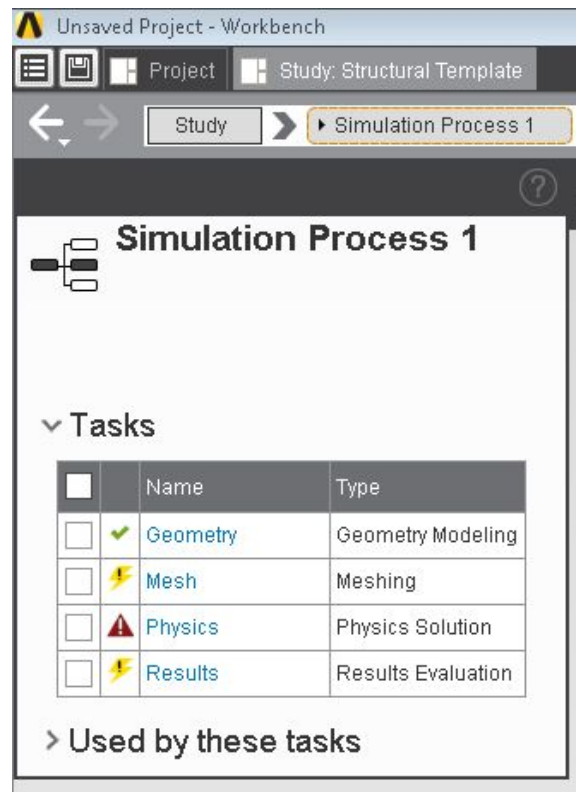

Unsaved Project - Workbench

Project Study: Structural Template

Study Simulation Process 1

Simulation Process 1

Tasks

<input type="checkbox"/>	Name	Type
<input type="checkbox"/>	✓ Geometry	Geometry Modeling
<input type="checkbox"/>	⚡ Mesh	Meshing
<input type="checkbox"/>	⚠ Physics	Physics Solution
<input type="checkbox"/>	⚡ Results	Results Evaluation

> Used by these tasks

- b. Next we need to use the built-in CAD software to combine all of our individual parts. In the **Simulation Process 1** panel click on the word **Geometry**.

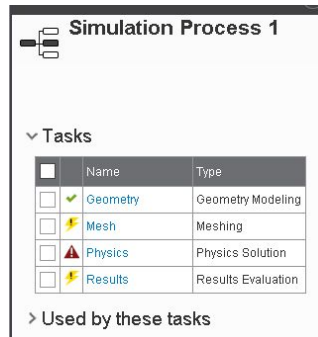

- c. In the next panel you can either **Replace Geometry** or **Edit Geometry**

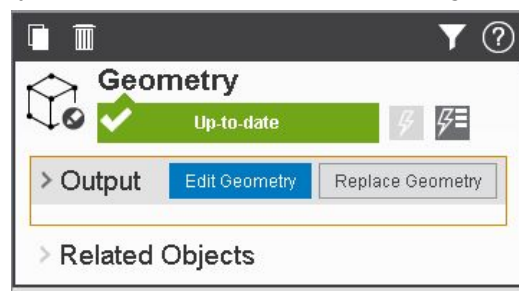

3. Preparing the Mesh

- a. In the **Workflow** area select **Mesh**.



- b. In the **Simulation Process** panel do not make any changes and click **Generate Mesh**.

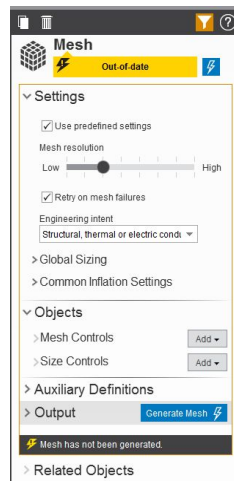

- c. The chair will now look like it has a net all over it which is the **Mesh**. The mesh represents the discretization of the physical domain into a mathematical model. The mesh enables AIM to assemble a system of equations, which are used to compute the physical response of the domain.

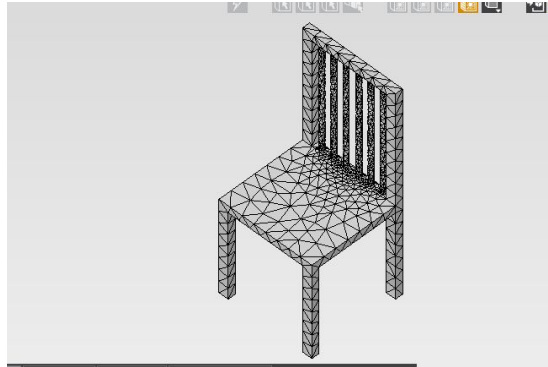

4. Assign Physics to the simulation

- a. In the **Workflow** menu select **Physics**

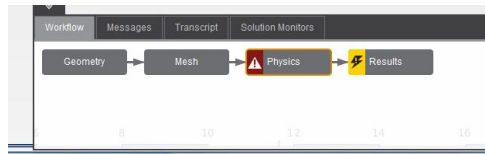

- b. In the **Physics Process** panel find the **Structural Conditions** item. Click on the **Add** button and select **Support**.

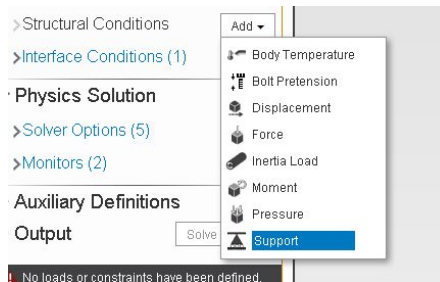

- c. The **Support 1** panel will open in the top left of the screen and under the **Location** box we will need to add the area of our model where the support of the ground will be located. In our case it will be at the bottom of each leg.

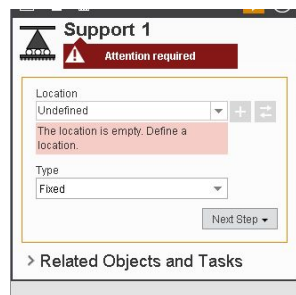

- d. Next, navigate to the **bottom** of your **chair** by **clicking on the chair and dragging your mouse until you can see the bottom**.

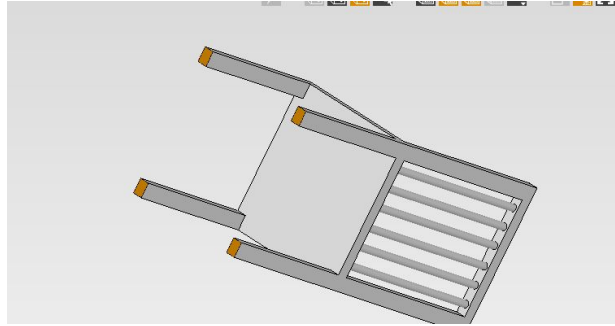

- e. To actually select the bottom of the legs you need to use the **Selection Buttons** located in menu on the **top-right** of the screen. Make sure that the **Face Selection** button is selected which is indicated by the it being shown as orange.



- f. Click the **Bottom Face** of each leg **holding CTRL** to select this face, which will turn orange.

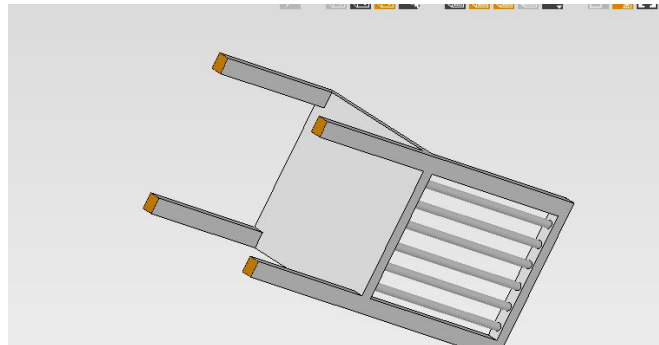

- g. Finally, with the face selected go **Support 1 Panel** and in the **Location** box click the **Plus Button** to add the face to the **Support 1 Condition**.

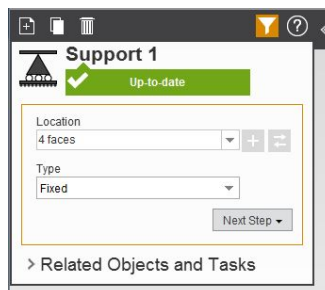

5. Define the Pressure Structural Condition

- a. Return to the **Physics Process Panel** by selecting it in the **Workflow Panel**.

- b. Add another **Structural Condition** using the **Add** button located next to the **Structural Conditions** line and select **Pressure**.

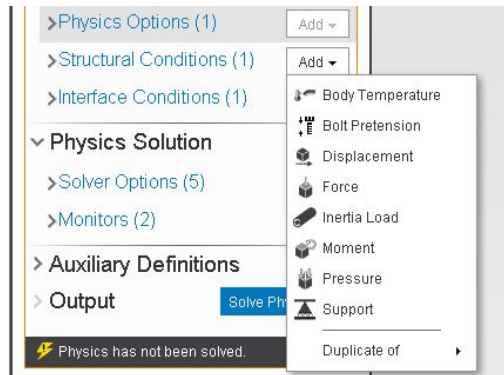

- c. The **Pressure 1 Conditions Panel** will appear in the top-left of the screen and just like with the **Support 1** condition we will need to add a location where the pressure will be applied to our structure.
- d. Using the same method of navigating around the chair, select the **top face of seat**.

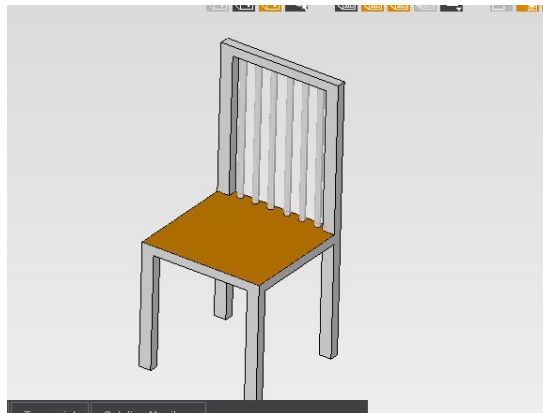

- e. Add these to the **Pressure Condition** by clicking the **Plus Button** in the **location** line of the **Pressure 1 Panel**.

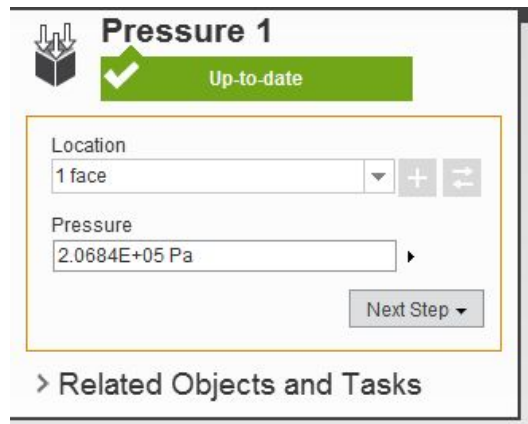

- f. Next we need to define the amount of pressure to be applied to the locations that you selected. Enter the amount of **each weight of the test requirements in Pascals**.

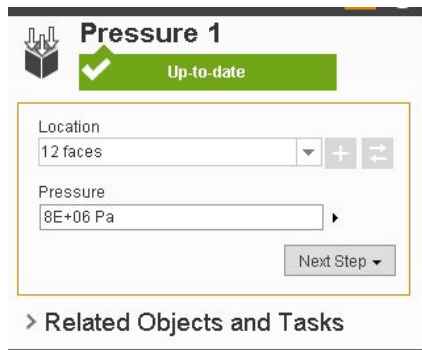

- g. Finally, click the **Physics** button located in the **Workflow** menu to return to the **Physics Process Panel**. To complete the Physics portion of this simulation click the **Solve Physics** button located at the bottom of the this panel.



6. Run the Simulation and Evaluate Results

- a. Click Evaluate in Workflow

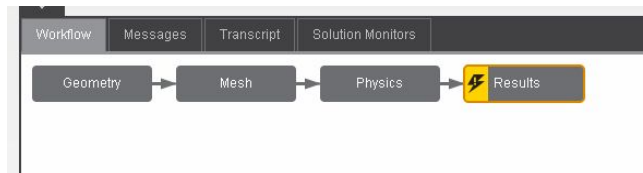

- b. In the **Evaluate Process Panel** click on the **Evaluate Results** button to run the simulation.

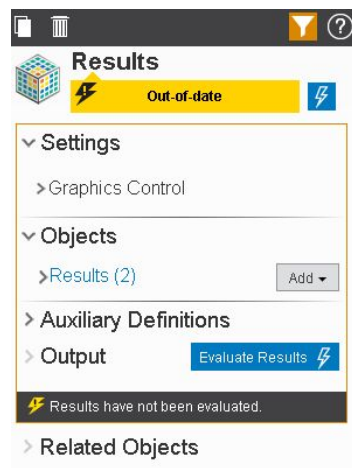

- c. The **Results Process Panel** will then show an **“Up to Date”** symbol in green.

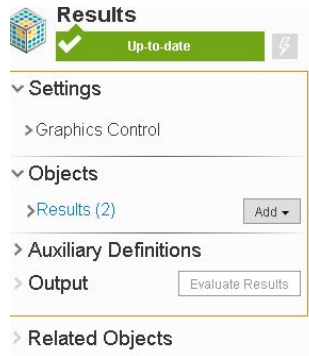

- d. Now we can see the results by click on the word **Results** in this panel. Doing this will bring up another menu with two items, **Equivalent Stress** and **Displacement Magnitude**. Clicking the arrows located in the top-left will allow you to navigate between the two results.

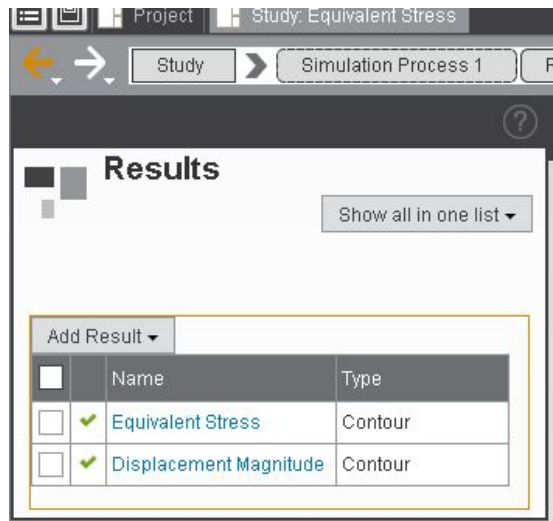

- e. Selecting one of these will bring up the results with the option to play an animation of the simulation. To play the animation click on the play button located above your building.

